

09/08/09

STATE OF NORTH CAROLINA
DIVISION OF HIGHWAYS

STATE	STATE PROJECT REFERENCE NO.	SHEET NO.	TOTAL SHEETS
N.C.	R-5790JG	1	
STATE PROJ. NO.	F.A. PROJ. NO.	DESCRIPTION	
44920.3.15	TAP-00SS(061)	CONST	

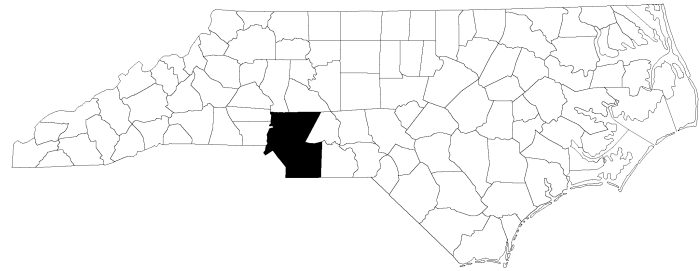

DIVISIONWIDE

GROUP A-1

LOCATION: MECKLENBURG COUNTY
TYPE OF WORK: CURB RAMP INSTALLATIONS

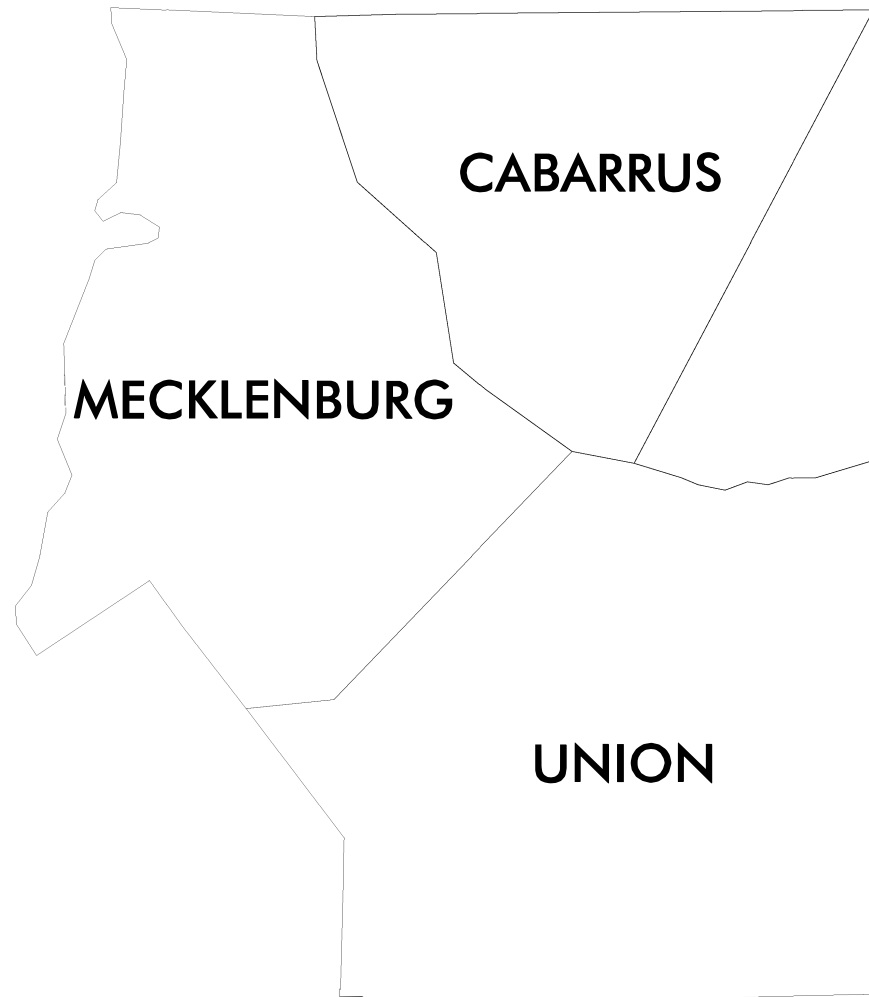

TIP PROJECT: R-5790JG

CONTRACT: DJ00362

1/2/2020
User: mtidolino

Prepared in the Office of:
DIVISION OF HIGHWAYS
1000 Birch Ridge Dr., Raleigh NC, 27610

2018 STANDARD SPECIFICATIONS

RIGHT OF WAY DATE:

TERRY W. BURLESON
PROJECT ENGINEER

LETTING DATE:

RAMEY KEMP & ASSOCIATES
PROJECT DESIGN ENGINEER

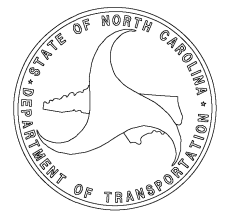

SUMMARY OF QUANTITIES - DIVISION 10 OVER 5000 GROUP A-1
COUNTY: MECKLENBURG

TIP Project: R-5790JG
WBS: 44920.3.15

Ramp ID	Map Number	Inset Number	Route 1	Route 2	2549000000-E	2591000000-E	2845000000-N	2830000000-N	7648000000-N	5888000000-E	Dome Style/Color	2600000000-N	2613000000-N	2605000000-N	Ramp Type
					2'-6" Concrete Curb & Gutter LF	4" Concrete Sidewalk SY	Adjust Valve / Meter EA	Adjust Manhole EA	Relocate Sign EA	Adjust Utility Box EA		Retrofit Existing Curb Ramps EA	Remove & Replace Curb EA	Concrete Curb Ramps EA	
1094	1-01	1	Sam Wilson Rd	Bedford Rd							Black		1		Standard 848.06
1091	1-01	2	Sam Wilson Rd	Air Park West Dr							Black		1		Standard 848.06
1092	1-01	2	Sam Wilson Rd	Air Park West Dr							Black		1		Standard 848.06
1089	1-01	3	Sam Wilson Rd	Air Park West Dr							Black		1		Standard 848.06
1090	1-01	3	Sam Wilson Rd	Air Park West Dr							Black		1		Type 3 Modified
1086	1-01	5	Old Dowd Rd	McGarry Trail			2				Black		1		Type 2B
1087	1-01	5	Old Dowd Rd	McGarry Trail							Black		1		Standard 848.06
1085	1-01	6	Old Dowd Rd	Amos Smith Rd							Black	1			Retrofit
2606	1-01	6	Old Dowd Rd	Amos Smith Rd							Black	1			Retrofit
											Black				
											Black				
											Black				
											Black				
											Black				
											Black				
1080	1-01	8	Amos Smith Rd	River Walk Way							Black		1		Standard 848.06
623	1-02	9	Brown Grier Rd	Cedar Hill Dr							Black		1		Standard 848.06
											Black				
											Black				
											Black				
											Black				
											Black				
											Black				
											Black				
505	1-03	12	South Tryon St (NC 49)	Tamarack Dr							Black		1		Type 2B
503	1-03	13	Riverpointe Dr	Eagleview Dr							Black		1		Type 1 Modified
504	1-03	13	Riverpointe Dr	Eagleview Dr							Black		1		Type 1 Modified
501	1-03	14	Riverpointe Dr	Woodland Ridge Ln							Black		1		Type 1 Modified
502	1-03	14	Riverpointe Dr	Woodland Ridge Ln			1				Black		1		Type 1 Modified
499	1-03	15	York Rd (NC 49)	Grand Palisades Pkwy							Black	1			Retrofit
500	1-03	15	York Rd (NC 49)	Grand Palisades Pkwy							Black	1			Retrofit
2593	1-03	15	York Rd (NC 49)	Grand Palisades Pkwy							Black	1			Retrofit
507	1-04	16	South Tryon St (NC 49)	York Ridge Shopping Center Driveway							Black		1		Type 1 Modified
509	1-04	16	South Tryon St (NC 49)	York Ridge Shopping Center Driveway							Black		1		Type 1 Modified
510	1-04	17	South Tryon St (NC 49)	South Point Blvd			2				Black		1		Type 1 Modified
511	1-04	17	South Tryon St (NC 49)	South Point Blvd			1				Black		1		Type 3 Modified
2594	1-04	18	South Tryon St (NC 49)	Steele Creek Business Park							Black	1			Retrofit
2595	1-04	18	South Tryon St (NC 49)	Steele Creek Business Park							Black		1		Type 1 Modified
512	1-04	19	South Tryon St (NC 49)	Carowinds Blvd							Black		1		Type 3 Modified
2596	1-04	20	South Tryon St (NC 49)	Carowinds Blvd							Black		1		Type 3 Modified
2597	1-04	20	South Tryon St (NC 49)	Carowinds Blvd							Black		1		Type 3 Modified
2598	1-04	20	South Tryon St (NC 49)	Carowinds Blvd							Black		1		Type 3 Modified
516	1-04	21	South Tryon St (NC 49)	Shell Gas Station Driveway							Black		1		Type 1 Modified
517	1-04	21	South Tryon St (NC 49)	Shell Gas Station Driveway							Black	1			Retrofit
518	1-04	22	South Tryon St (NC 49)	SE Credit Union Driveway							Black		1		Type 1 Modified
519	1-04	22	South Tryon St (NC 49)	SE Credit Union Driveway							Black		1		Type 1 Modified
520	1-04	23	South Tryon St (NC 49)	Crescent Springs Dr							Black	1			Retrofit
521	1-04	23	South Tryon St (NC 49)	Crescent Springs Dr							Black	1			Retrofit
522	1-05	24	South Tryon St (NC 49)	Aldi Driveway							Black		1		Type 1 Modified
523	1-05	24	South Tryon St (NC 49)	Aldi Driveway							Black		1		Type 1 Modified
524	1-05	25	South Tryon St (NC 49)	American Storage Driveway							Black		1		Type 1 Modified
525	1-05	25	South Tryon St (NC 49)	American Storage Driveway							Black		1		Type 1 Modified
526	1-05	26	South Tryon St (NC 49)	American Storage Driveway							Black		1		Type 1 Modified
527	1-05	26	South Tryon St (NC 49)	American Storage Driveway							Black		1		Type 1 Modified
528	1-05	27	South Tryon St (NC 49)	American Wash Systems Driveway							Black	1			Retrofit
529	1-05	27	South Tryon St (NC 49)	American Wash Systems Driveway							Black		1		Type 1 Modified
530	1-05	27	South Tryon St (NC 49)	Carolina Specialty Metals Driveway							Black		1		Type 1 Modified
531	1-05	27	South Tryon St (NC 49)	Carolina Specialty Metals Driveway							Black		1		Type 3 Modified
532	1-05	28	South Tryon St (NC 49)	Forbo Driveway							Black	1			Retrofit
533	1-05	28	South Tryon St (NC 49)	Forbo Driveway							Black	1			Retrofit
534	1-06	29	South Tryon St (NC 49)	Nevada Blvd							Black		1		Type 3 Modified
535	1-06	30	South Tryon St (NC 49)	Yale Parts Driveway							Black			1	Type 1 Modified
536	1-06	30	South Tryon St (NC 49)	Yale Parts Driveway							Black		1		Type 1 Modified
537	1-06	31	South Tryon St (NC 49)	SC Animal Hospital Driveway							Black	1			Retrofit
538	1-06	31	South Tryon St (NC 49)	SC Animal Hospital Driveway							Black		1		Type 1 Modified
539	1-06	32	South Tryon St (NC 49)	John Price Rd							Black		1		Type 1 Modified

Ramp ID	Map Number	Inset Number	Route 1	Route 2	2549000000-E	2591000000-E	2845000000-N	2830000000-N	7648000000-N	5888000000-E	Dome Style/Color	2600000000-N	2613000000-N	2605000000-N	Ramp Type
					2'-6" Concrete Curb & Gutter LF	4" Concrete Sidewalk SY	Adjust Valve / Meter EA	Adjust Manhole EA	Relocate Sign EA	Adjust Utility Box EA		Retrofit Existing Curb Ramps EA	Remove & Replace Curb EA	Concrete Curb Ramps EA	
540	1-06	32	South Tryon St (NC 49)	John Price Rd							Black		1		Type 1 Modified
541	1-06	32	South Tryon St (NC 49)	John Price Rd							Black		1		Type 2
542	1-06	32	South Tryon St (NC 49)	John Price Rd							Black	1			Retrofit
2603	1-06	32	South Tryon St (NC 49)	John Price Rd							Black		1		Type 8
544	1-06	33	South Tryon St (NC 49)	Socrates Square Driveway							Black		1		Type 1 Modified
545	1-06	33	South Tryon St (NC 49)	Socrates Square Driveway							Black	1			Retrofit
546	1-06	34	South Tryon St (NC 49)	Westinghouse Blvd							Black	1			Retrofit
547	1-06	34	South Tryon St (NC 49)	Westinghouse Blvd				1			Black		1		Type 3 Modified
548	1-06	34	South Tryon St (NC 49)	Westinghouse Blvd							Black	1			Retrofit
549	1-06	34	South Tryon St (NC 49)	Westinghouse Blvd							Black	1			Retrofit
550	1-06	34	South Tryon St (NC 49)	Westinghouse Blvd							Black	1			Retrofit
551	1-06	35	South Tryon St (NC 49)	Public Storage Driveway							Black		1		Type 1 Modified
552	1-06	35	South Tryon St (NC 49)	Public Storage Driveway							Black		1		Type 1 Modified
553	1-06	35	South Tryon St (NC 49)	CMC Urgent Care Driveway							Black	1			Retrofit
554	1-06	35	South Tryon St (NC 49)	CMC Urgent Care Driveway							Black	1			Retrofit
555	1-06	36	South Tryon St (NC 49)	CMC Urgent Care Driveway							Black		1		Type 1 Modified
556	1-06	36	South Tryon St (NC 49)	CMC Urgent Care Driveway							Black		1		Type 1
557	1-06	36	South Tryon St (NC 49)	AutoBell Car Wash Driveway							Black		1		Type 1 Modified
558	1-06	36	South Tryon St (NC 49)	AutoBell Car Wash Driveway							Black		1		Type 1 Modified
559	1-07	37	South Tryon St (NC 49)	Fire Station Driveway							Black	1			Retrofit
560	1-07	37	South Tryon St (NC 49)	Bronwin St							Black	1			Retrofit
561	1-07	38	South Tryon St (NC 49)	Steele Creek Commons Driveway							Black	1			Retrofit
562	1-07	38	South Tryon St (NC 49)	Steele Creek Commons Driveway							Black		1		Type 1 Modified
563	1-07	39	South Tryon St (NC 49)	Sandy Porter Rd							Black		1		Type 8
2602	1-07	39	South Tryon St (NC 49)	Sandy Porter Rd							Black		1		Type 3
564	1-07	40	South Tryon St (NC 49)	Stone Ridge Apartments Driveway							Black	1			Retrofit
565	1-07	40	South Tryon St (NC 49)	Stone Ridge Apartments Driveway							Black	1			Retrofit
566	1-07	40	South Tryon St (NC 49)	Cambridge Beltway Dr							Black		1		Type 3 Modified
567	1-07	40	South Tryon St (NC 49)	Cambridge Beltway Dr							Black		1		Type 3 Modified
568	1-07	41	South Tryon St (NC 49)	Marathon Gas Station Driveway							Black		1		Type 1 Modified
569	1-07	41	South Tryon St (NC 49)	Marathon Gas Station Driveway							Black	1			Retrofit
570	1-07	42	South Tryon St (NC 49)	Marathon Gas Station Driveway						1	Black		1		Type 1 Modified
571	1-07	42	South Tryon St (NC 49)	Marathon Gas Station Driveway							Black		1		Type 1 Modified
572	1-07	42	South Tryon St (NC 49)	Hahn Eye Center Driveway							Black		1		Type 2B
573	1-07	42	South Tryon St (NC 49)	Hahn Eye Center Driveway							Black		1		Type 1 Modified
574	1-07	43	South Tryon St (NC 49)	485 On Ramp Outer	10	6					Black		1		Type 3 Modified
575	1-07	43	South Tryon St (NC 49)	485 On Ramp Outer							Black		1		Type 1A
496	1-09	49	Westinghouse Blvd	Granite St							Black		1		Type 2B
497	1-09	49	Westinghouse Blvd	Granite St							Black		1		Type 2B
498	1-09	49	Westinghouse Blvd	Granite St							Black		1		Type 2B
2585	1-09	49	Westinghouse Blvd	Granite St							Black			1	Type 6
2586	1-09	49	Westinghouse Blvd	Granite St							Black			1	Type 6
2587	1-09	49	Westinghouse Blvd	Granite St							Black			1	Type 6
2588	1-09	49	Westinghouse Blvd	Granite St							Black			1	Type 6
2607	1-09	49	Westinghouse Blvd	Granite St							Black			1	Type 6
488	1-09	50	Nations Ford Rd	Westinghouse Blvd							Black		1		Type 2B
489	1-09	50	Nations Ford Rd	Westinghouse Blvd							Black		1		Type 2B
493	1-09	50	Nations Ford Rd	Westinghouse Blvd							Black		1		Standard 848.06
479	1-09	51	East Westinghouse Blvd	Downs Rd			1				Black		1		Type 3 Modified
2589	1-09	51	East Westinghouse Blvd	Downs Rd							Black		1		Type 3 Modified
408	1-10	52	Alex Mill Dr	Jacobs Ridge Ct							Black		1		Type 3 Modified
409	1-10	52	Alex Mill Dr	Jacobs Ridge Ct							Black		1		Type 3 Modified
406	1-10	53	Harmon Ln	Alex Mill Dr							Black		1		Type 3 Modified
407	1-10	53	Harmon Ln	Alex Mill Dr							Black	1			Retrofit
404	1-10	54	Edgetree Dr	Treybrooke Ln							Black	1			Retrofit
405	1-10	54	Edgetree Dr	Treybrooke Ln							Black		1		Type 3 Modified
402	1-10	55	Honeytree Ln	Treybrooke Ln							Black		1		Type 3 Modified
403	1-10	55	Honeytree Ln	Treybrooke Ln							Black		1		Type 3 Modified
410	1-10	56	Lancaster Hwy	Rudolph Pl Dr							Black		1		Standard 848.06
411	1-10	56	Lancaster Hwy	Rudolph Pl Dr							Black		1		Standard 848.06
400	1-10	57	Edgetree Dr	Harmon Ln							Black	1			Retrofit
401	1-10	57	Edgetree Dr	Harmon Ln							Black	1			Retrofit
399	1-10	58	Edgetree Dr	Autumn Winds Ln							Black	1			Retrofit
398	1-10	59	Cardinal Woods Dr	Edgetree Dr							Black		1		Type 2A Modified
396	1-11	60	Danby Rd	Gatestone Ln			1				Black		1		Type 3 Modified
397	1-11	60	Danby Rd	Gatestone Ln							Black		1		Type 1 Modified
394	1-11	61	Lancaster Hwy	Danby Rd							Black	1			Retrofit
391	1-11	62	Lancaster Hwy	Wynhollow Downs Ln							Black		1		Type 3 Modified
392	1-11	62	Lancaster Hwy	Wynhollow Downs Ln							Black		1		Type 3 Modified
TOTALS:					10	6	8	1	0	1	-	33	83	6	
					2549000000-E	2591000000-E	2845000000-N	2830000000-N	7648000000-N	5888000000-E		2600000000-N	2613000000-N	2605000000-N	
					2'-6" Concrete Curb & Gutter LF	4" Concrete Sidewalk SY	Adjust Valve / Meter EA	Adjust Manhole EA	Relocate Sign EA	Adjust Utility Box EA		Retrofit Existing Curb Ramps EA	Remove & Replace Curb EA	Concrete Curb Ramps EA	

Incidental Quantities	
2549000000-E	1220000000-E
2'-6" Concrete Curb & Gutter LF	Incidental Stone TON
250	10

NOTES: INCIDENTAL QUANTITIES SHALL BE USED AS DIRECTED BY THE ENGINEER.
 TOKEN QUANTITIES WILL BE ADDED FOR RESET EXISTING GRANITE CURB AND AGGREGATE BASE COURSE IN CASE GRANITE CURBING IS ENCOUNTERED.

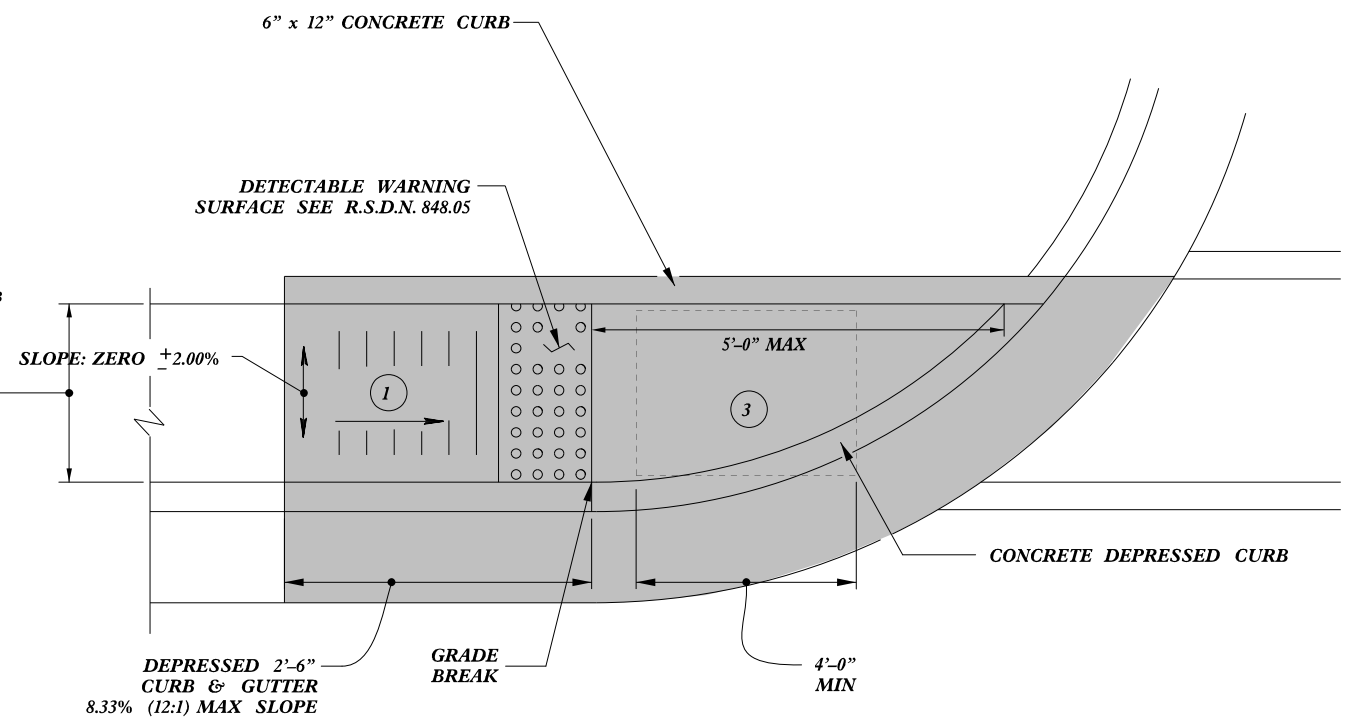
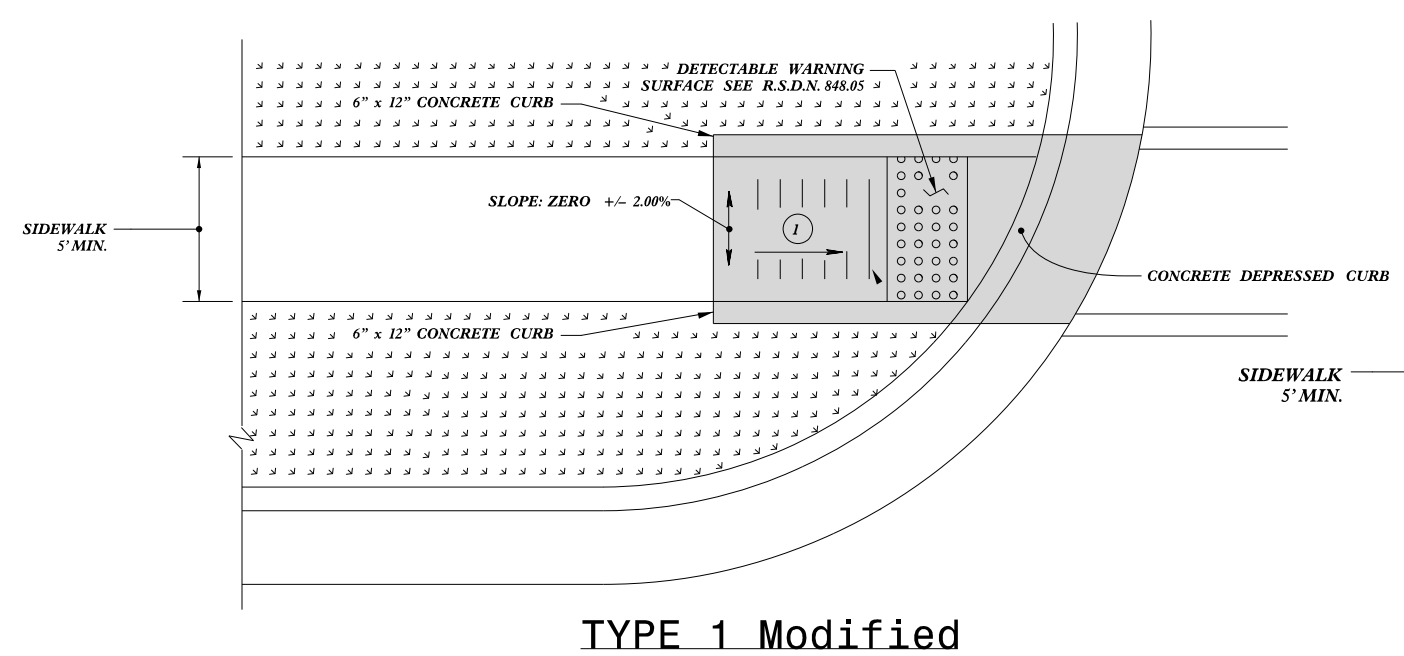
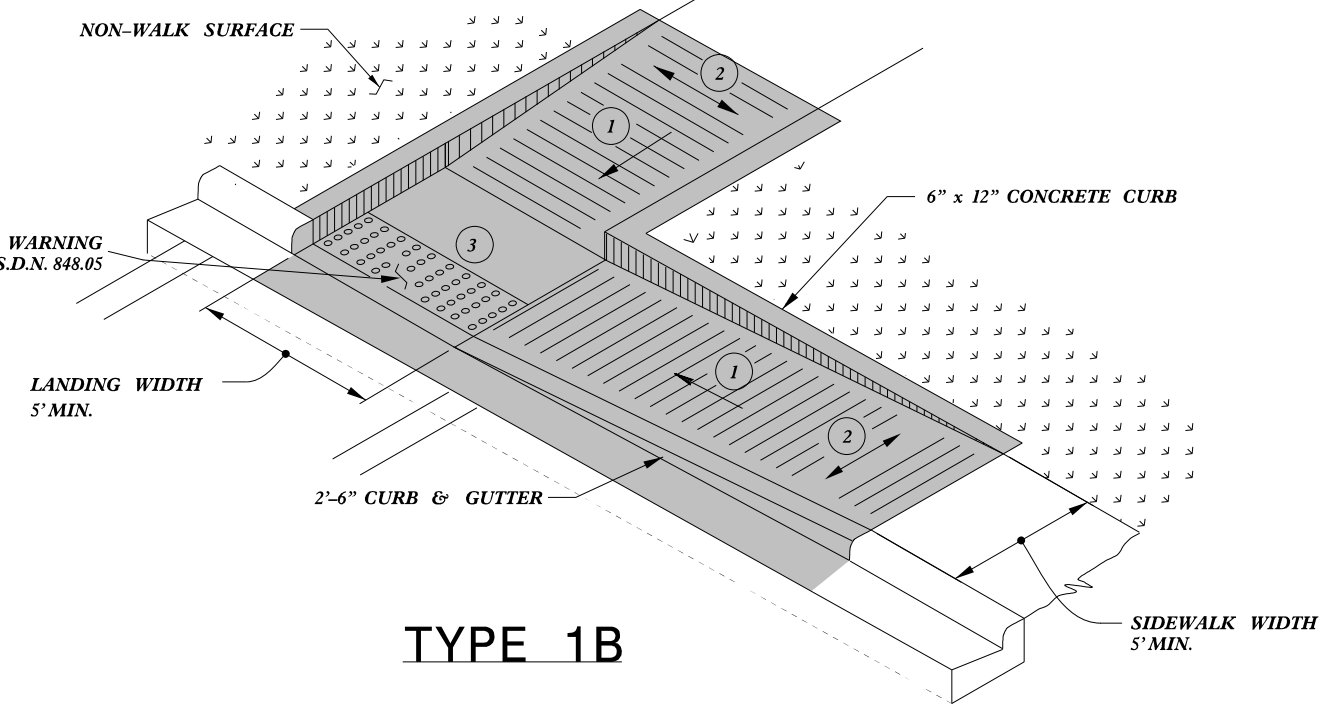
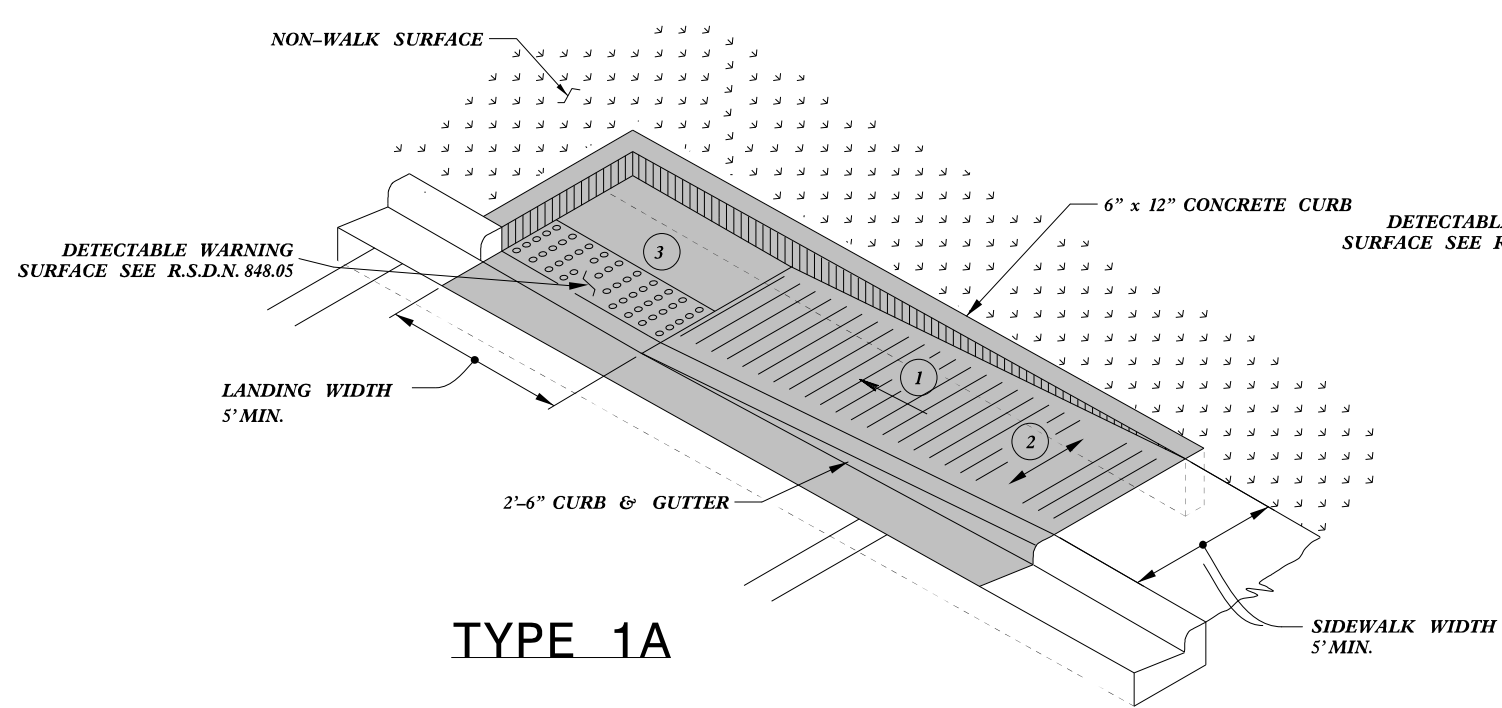

- 1 8.33% (12:1) MAX RAMP SLOPE
- 2 CROSS SLOPE: 2.00%
- 3 CURB RAMPS REQUIRE A (4'-0") MINIMUM LANDING WITH A MAXIMUM CROSS SLOPE AND LONGITUDINAL SLOPE OF 2.00% WHERE PEDESTRIANS PERFORM TURNING MANEUVERS. SLOPE TO DRAIN TO CURB.



PAY LIMITS FOR 1 CURB RAMP

REFER TO ROADWAY STANDARD DRAWING NUMBER 848.05 SHEET 3 OF 3 FOR ALL RAMP NOTES



DOCUMENT NOT CONSIDERED FINAL UNLESS ALL SIGNATURES COMPLETED

CONTRACT STANDARDS AND DEVELOPMENT UNIT
Office 919-707-6950 FAX 919-250-4119

CURB RAMPS
Directional Ramps

ORIGINAL BY: J.S. HOWERTON DATE: 7/7/11
 MODIFIED BY: _____ DATE: _____
 CHECKED BY: _____ DATE: _____
 FILE SPEC: stds/2012CurbRamp/CurbRampDetails.dgn

5/14/99 SYSTEMS DESIGN & CONSTRUCTION

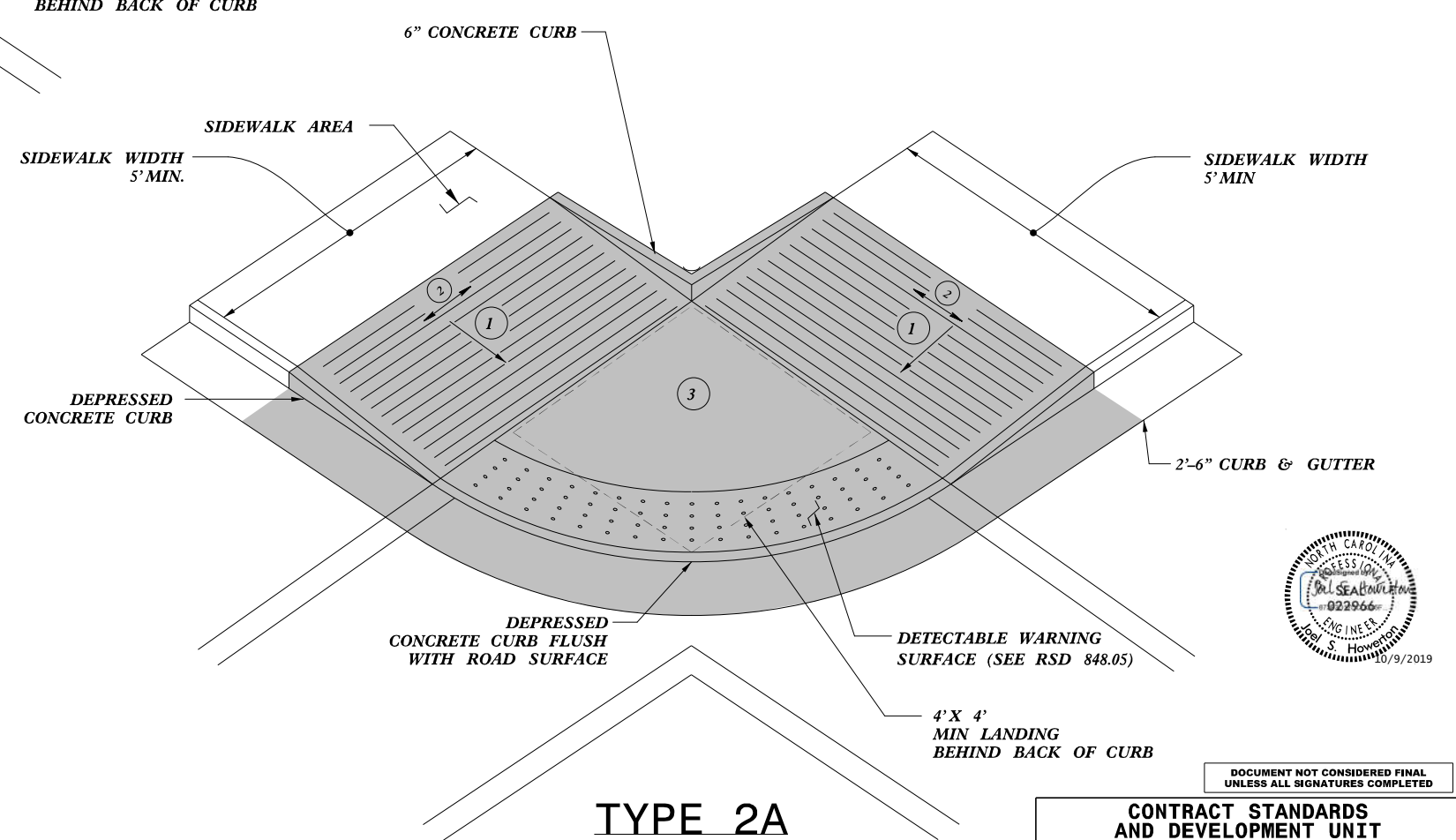
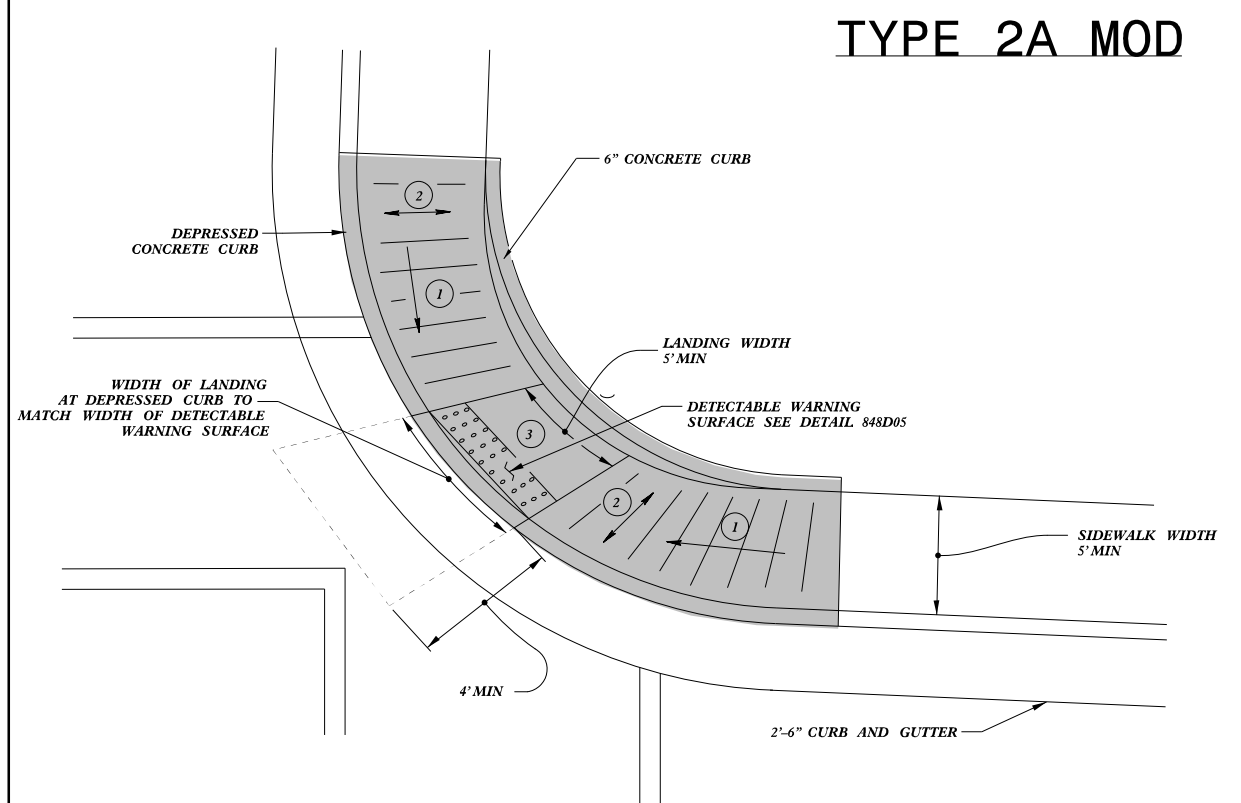
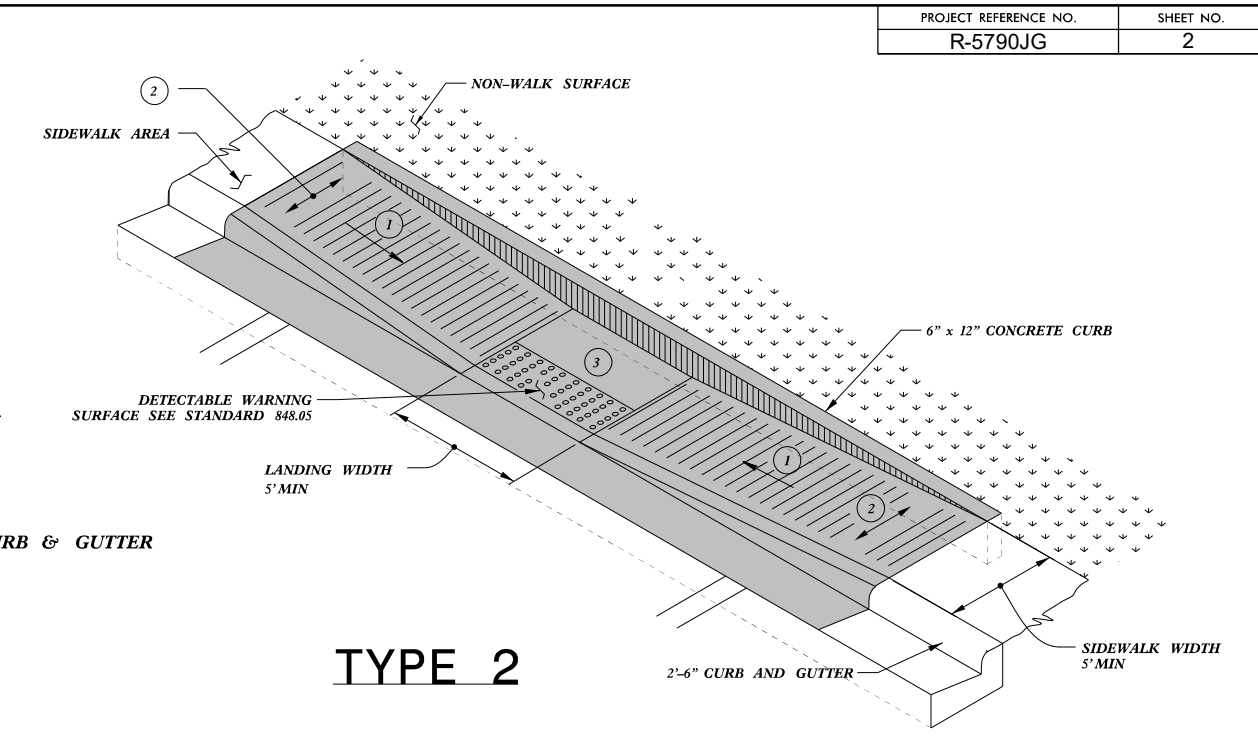
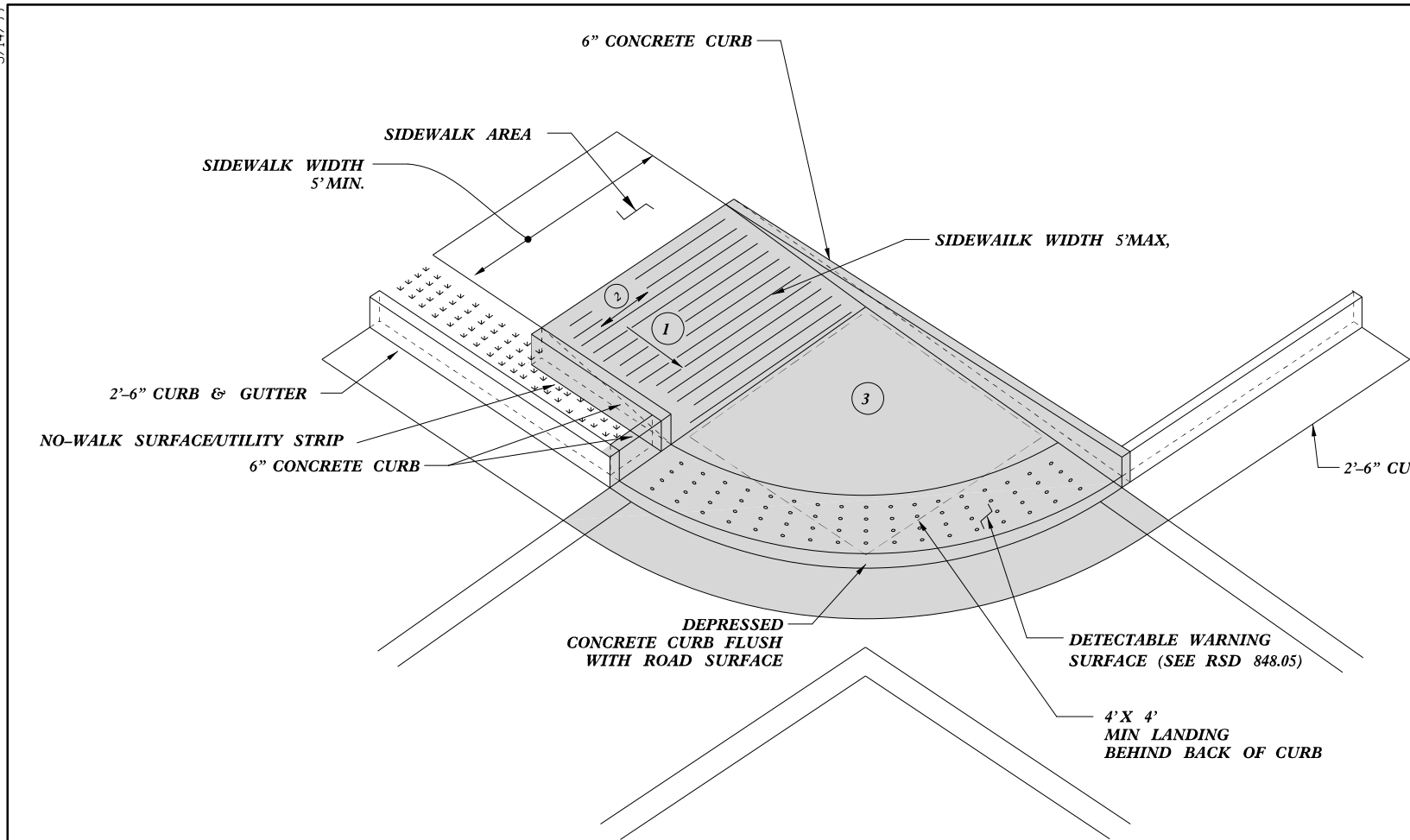

- 1 8.33% (12:1) MAX RAMP SLOPE
- 2 CROSS SLOPE: 2.00%
- 3 CURB RAMPS REQUIRE A (4'-0") MINIMUM LANDING WITH A MAXIMUM CROSS SLOPE AND LONGITUDINAL SLOPE OF 2.00% WHERE PEDESTRIANS PERFORM TURNING MANEUVERS. SLOPE TO DRAIN TO CURB.

PAY LIMITS FOR 1 CURB RAMP



DOCUMENT NOT CONSIDERED FINAL UNLESS ALL SIGNATURES COMPLETED

CONTRACT STANDARDS AND DEVELOPMENT UNIT	
Office 919-707-6950	FAX 919-250-4119
CURB RAMPS	
ORIGINAL BY: J.S. HOWERTON	DATE: 7/7/11
MODIFIED BY:	DATE:
CHECKED BY:	DATE:
FILE SPEC: stds/2012CurbRamp/CurbRampDetails.dgn	

5/14/99 SYSTEMS ENGINEERING

PAY LIMITS FOR 1 CURB RAMP

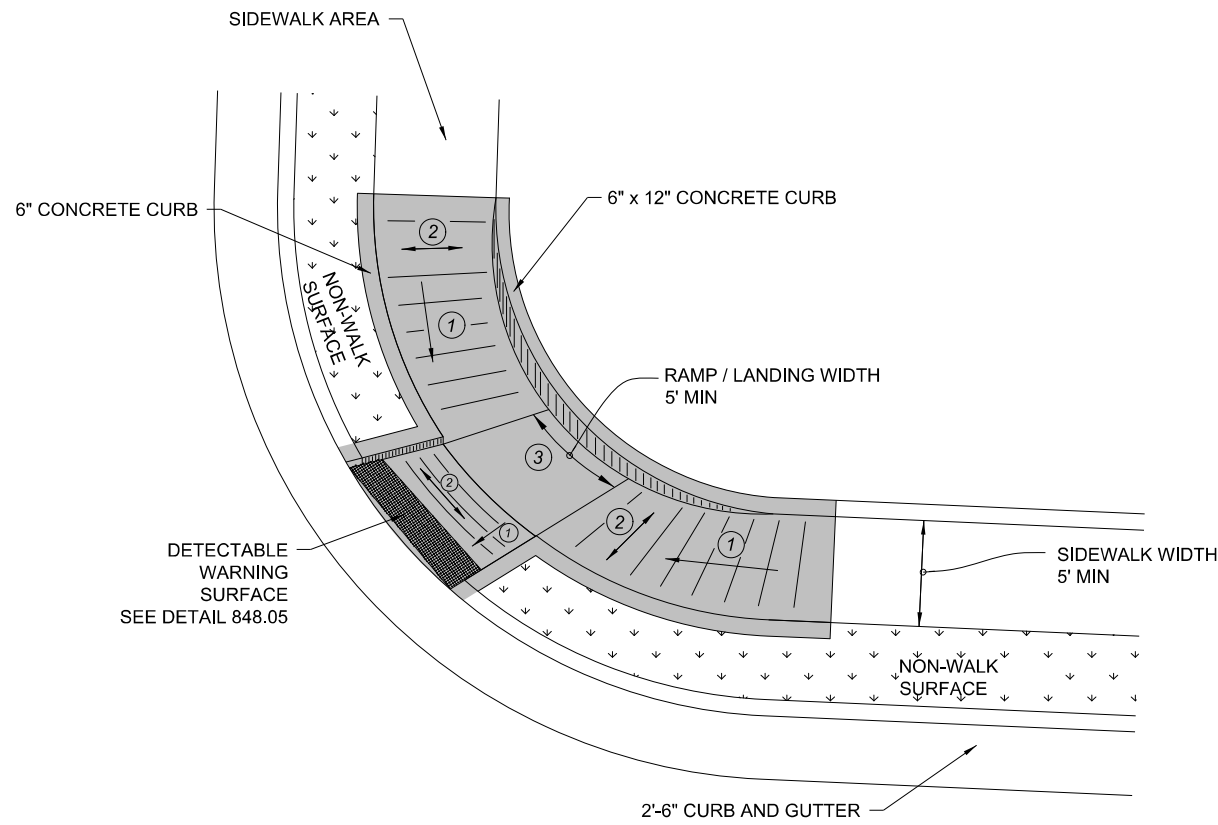

**TYPE 3 MODIFIED
INSTALLATION IN A RADIUS**

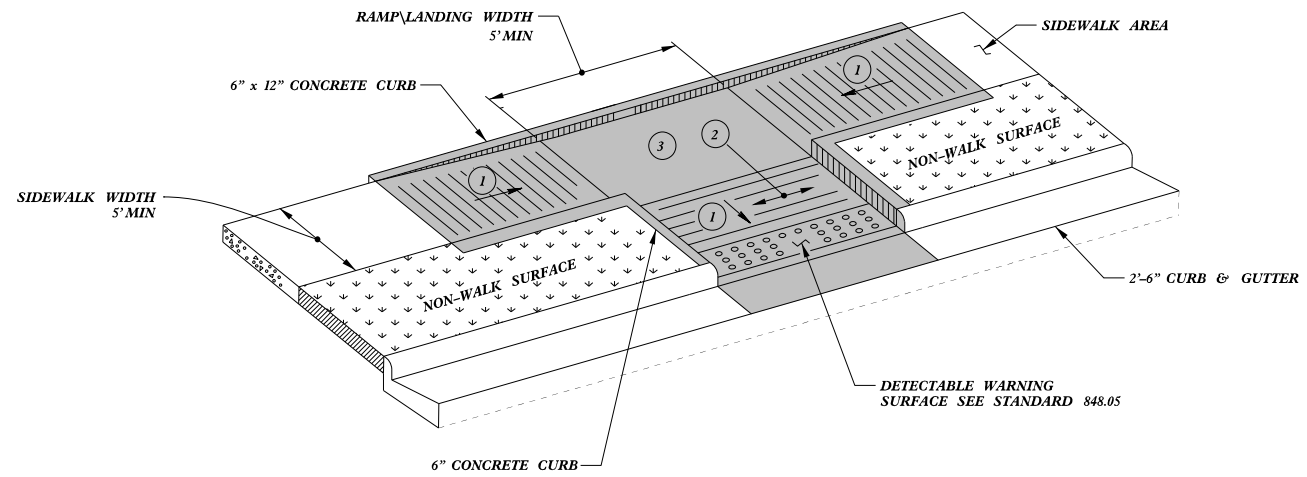

TYPE 3

- 1 8.33% (12:1) MAX RAMP SLOPE
- 2 CROSS SLOPE: 2.00%
- 3 CURB RAMPS REQUIRE A (4'-0") MINIMUM LANDING WITH A MAXIMUM CROSS SLOPE AND LONGITUDINAL SLOPE OF 2.00% WHERE PEDESTRIANS PERFORM TURNING MANEUVERS. SLOPE TO DRAIN TO CURB.



DOCUMENT NOT CONSIDERED FINAL UNLESS ALL SIGNATURES COMPLETED

CONTRACT STANDARDS AND DEVELOPMENT UNIT

Office 919-707-6950 FAX 919-250-4119

CURB RAMPS

ORIGINAL BY: J.S. HOWERTON DATE: 7/7/11
 MODIFIED BY: _____ DATE: _____
 CHECKED BY: _____ DATE: _____
 FILE SPEC: stds/2012CurbRamp/CurbRampDetails.dgn

SYSTEM GENERATED FROM THE PROJECT DATA

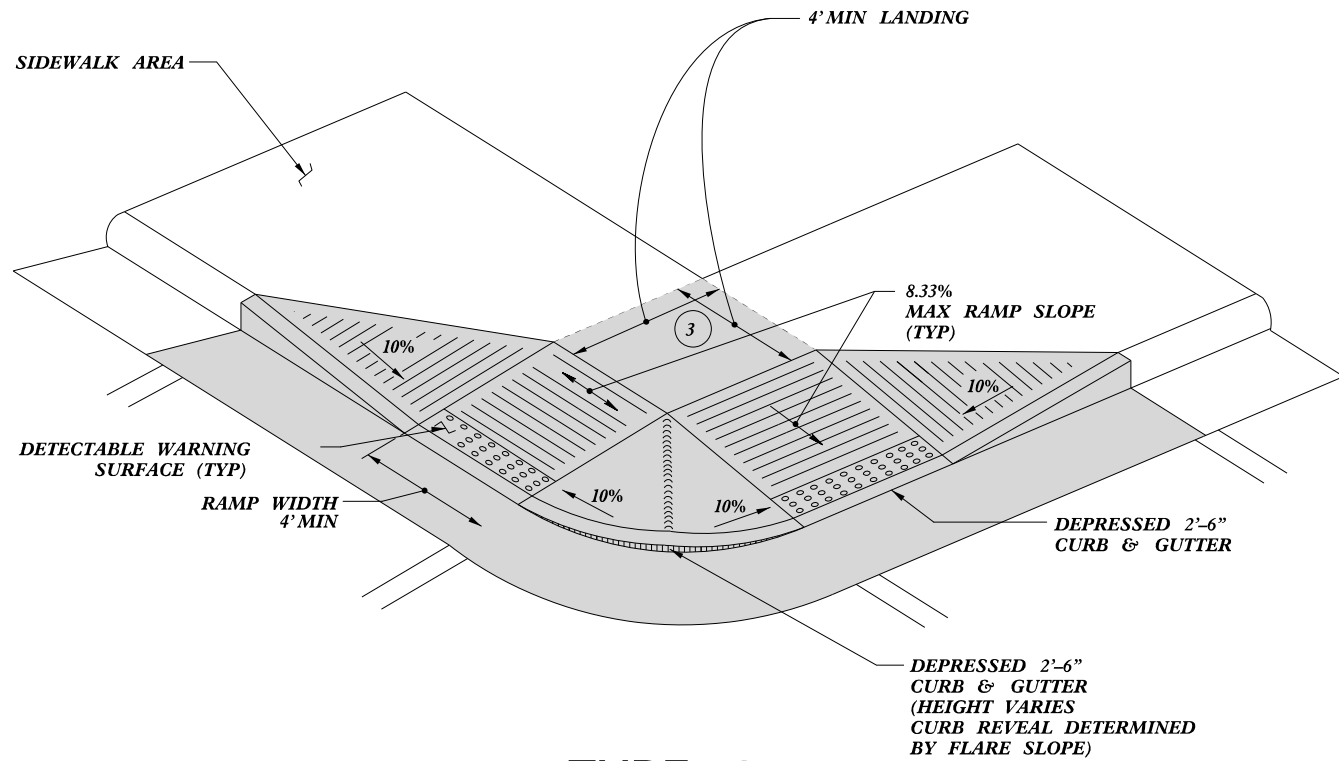

TYPE 4

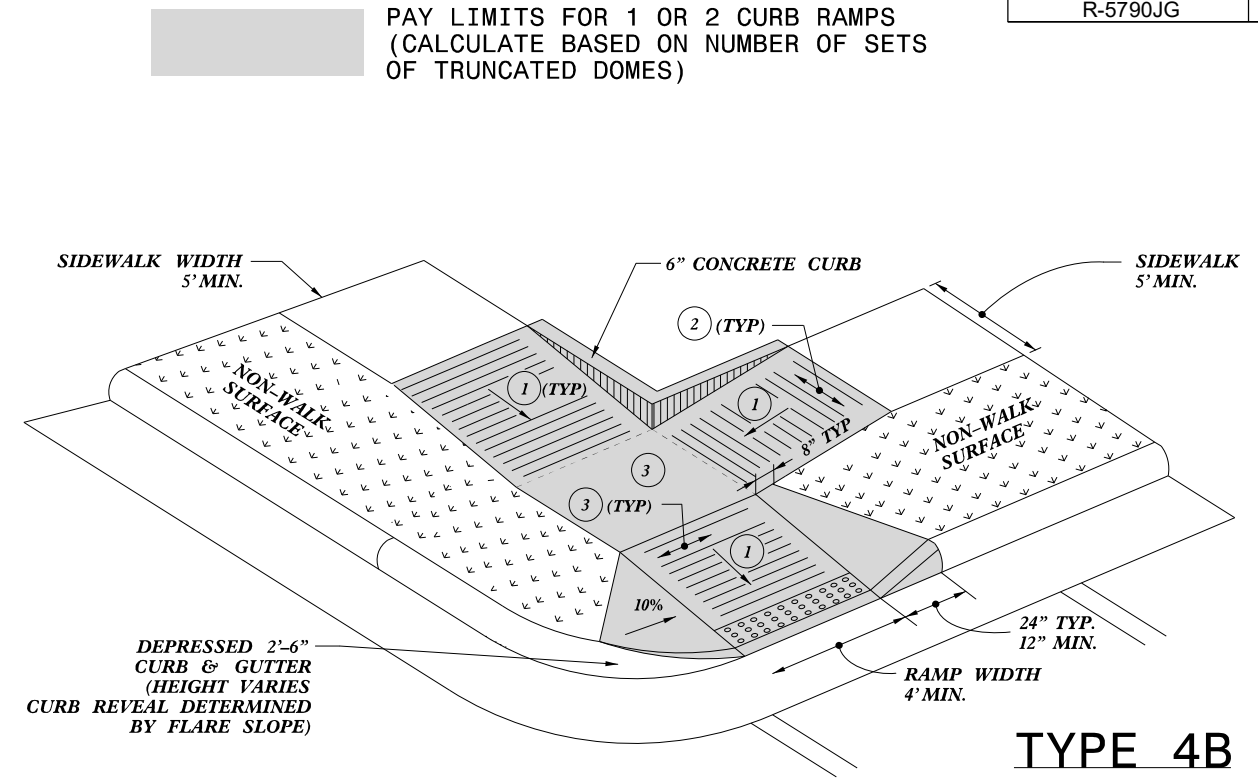

TYPE 4B

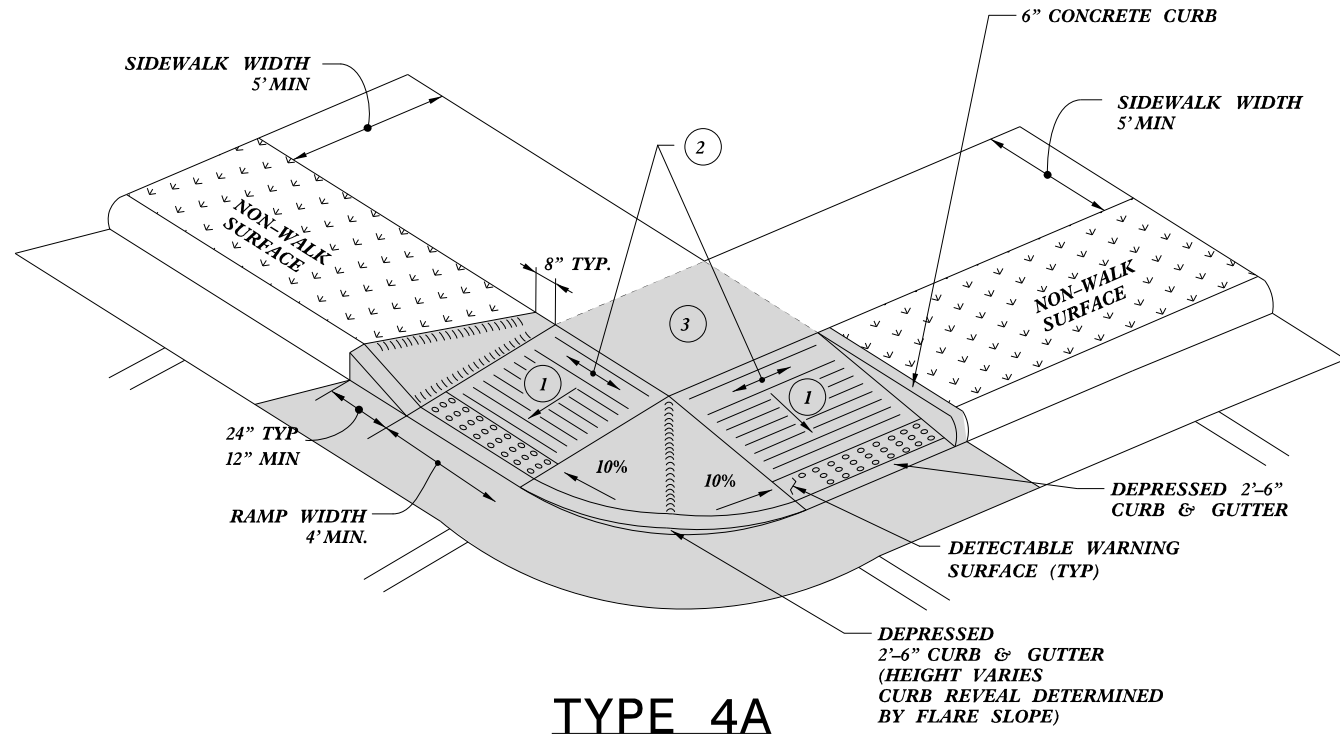

TYPE 4A

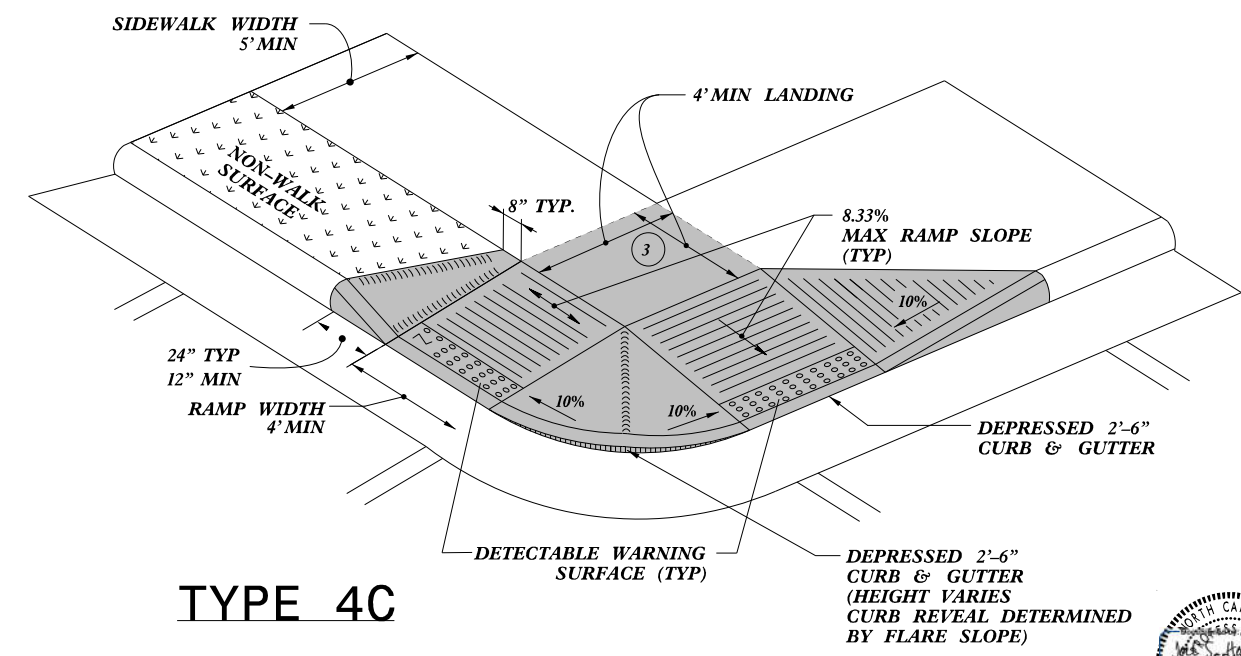

TYPE 4C

- 1 8.33% (12:1) MAX RAMP SLOPE
- 2 CROSS SLOPE: 2.00%
- 3 CURB RAMPS REQUIRE A (4'-0") MINIMUM LANDING WITH A MAXIMUM CROSS SLOPE AND LONGITUDINAL SLOPE OF 2.00% WHERE PEDESTRIANS PERFORM TURNING MANEUVERS. SLOPE TO DRAIN TO CURB.



10/9/2019

CONTRACT STANDARDS AND DEVELOPMENT UNIT	
Office 919-707-6950	FAX 919-250-4119
CURB RAMPS	
ORIGINAL BY: J.S. HOWERTON	DATE: 7/7/11
MODIFIED BY:	DATE:
CHECKED BY:	DATE:
FILE SPEC. stds/2012CurbRamp/CurbRampDetails.dgn	

REFER TO ROADWAY STANDARD DRAWING NUMBER 848.05 SHEET 3 OF 3 FOR ALL RAMP NOTES

5/14/99
 SYSTEMS ENGINEERING
 022956
 J.S. HOWERTON
 PROFESSIONAL ENGINEER
 STATE OF NORTH CAROLINA

PAY LIMITS FOR 1 OR 2 CURB RAMPS
 (CALCULATE BASED ON NUMBER OF SETS
 OF TRUNCATED DOMES)

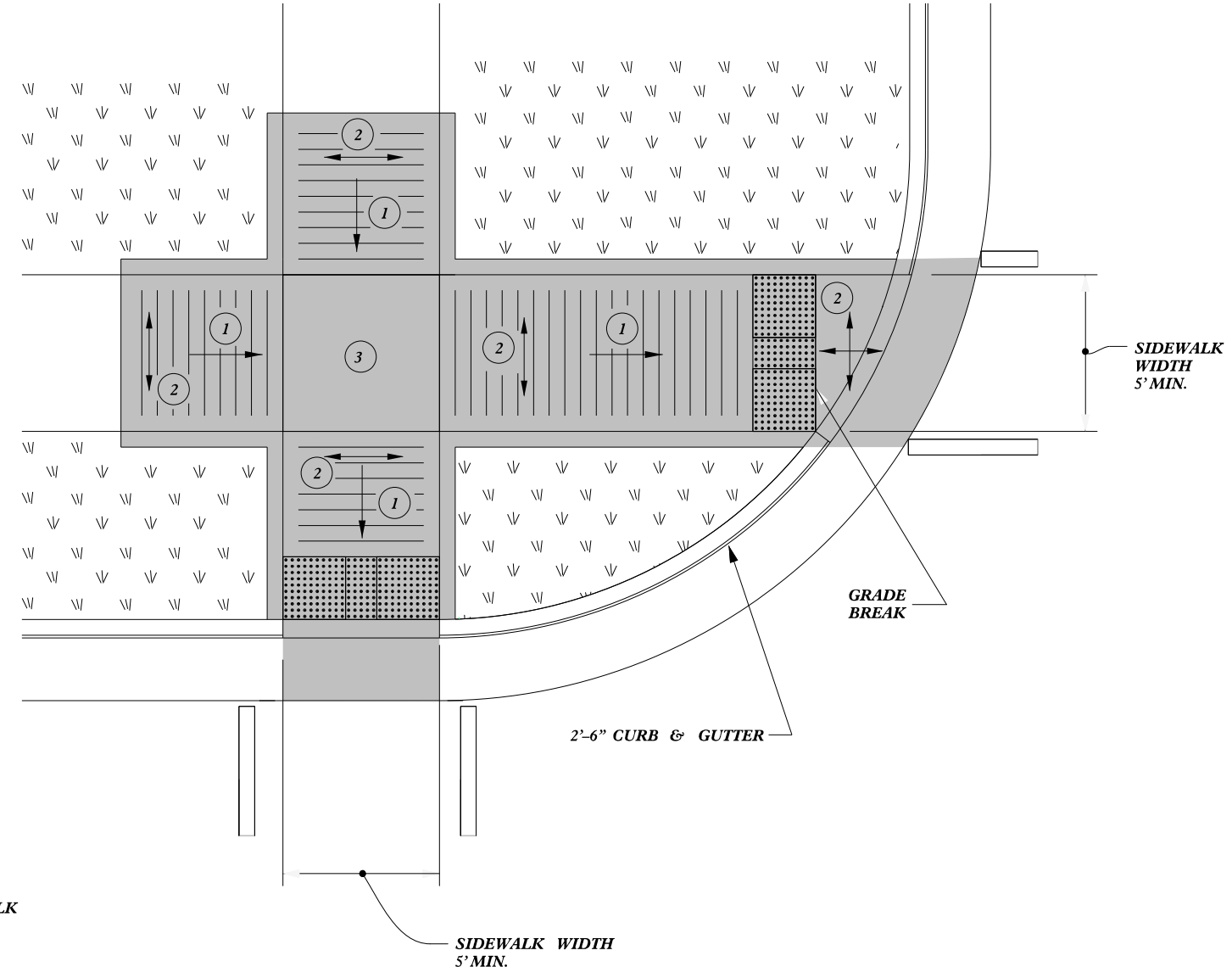

TYPE 5A

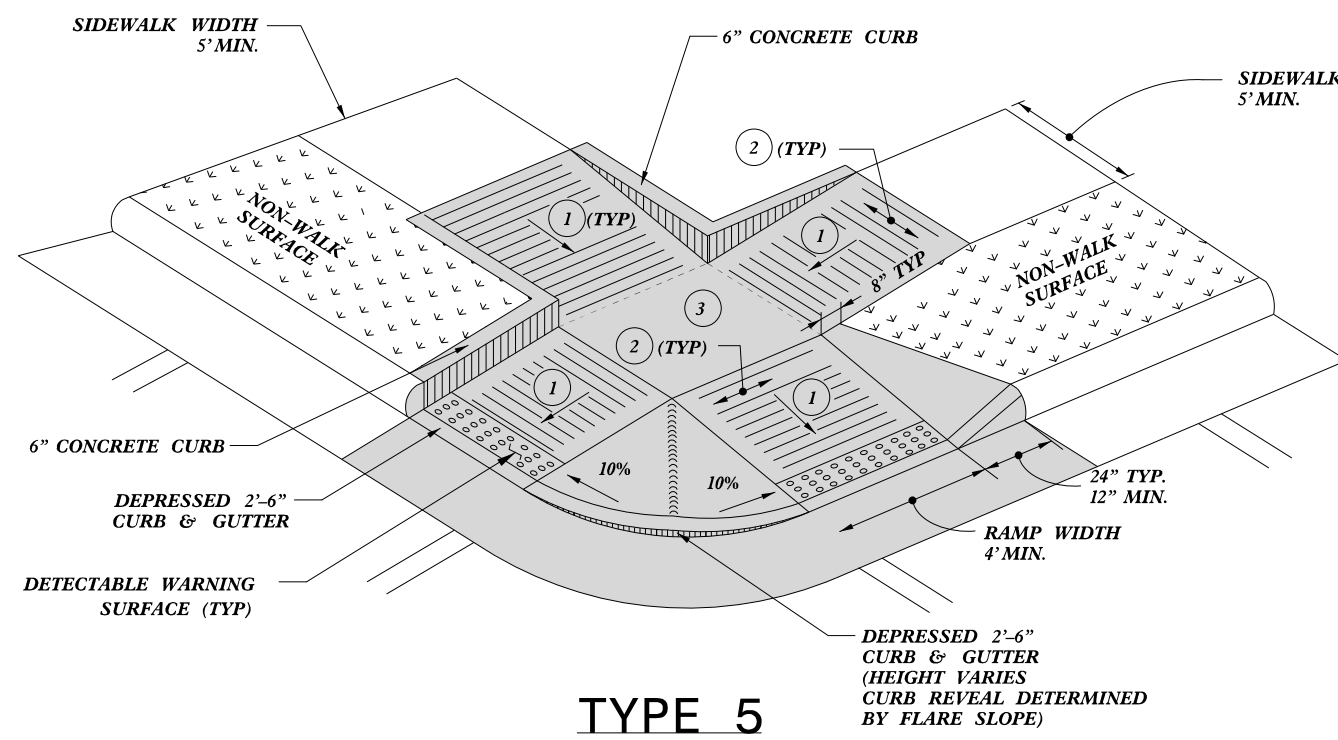

TYPE 5

- 1 8.33% (12:1) MAX RAMP SLOPE
- 2 CROSS SLOPE: 2.00%
- 3 CURB RAMPS REQUIRE A (4'-0") MINIMUM LANDING WITH A MAXIMUM CROSS SLOPE AND LONGITUDINAL SLOPE OF 2.00% WHERE PEDESTRIANS PERFORM TURNING MANEUVERS. SLOPE TO DRAIN TO CURB.



10/9/2019

CONTRACT STANDARDS AND DEVELOPMENT UNIT	
Office 919-707-6950	FAX 919-250-4119
CURB RAMPS	
ORIGINAL BY: J.S. HOWERTON	DATE: 7/7/11
MODIFIED BY:	DATE:
CHECKED BY:	DATE:
FILE SPEC: stds/2012CurbRamp/CurbRampDetails.dgn	

REFER TO ROADWAY STANDARD DRAWING NUMBER 848.05 SHEET 3 OF 3 FOR ALL RAMP NOTES

SYSTEM GENERATED \$\$\$\$\$\$

PAY LIMITS FOR 2 OR 3 CURB RAMPS
(CALCULATE BASED ON NUMBER OF
SETS OF TRUNCATED DOMES)

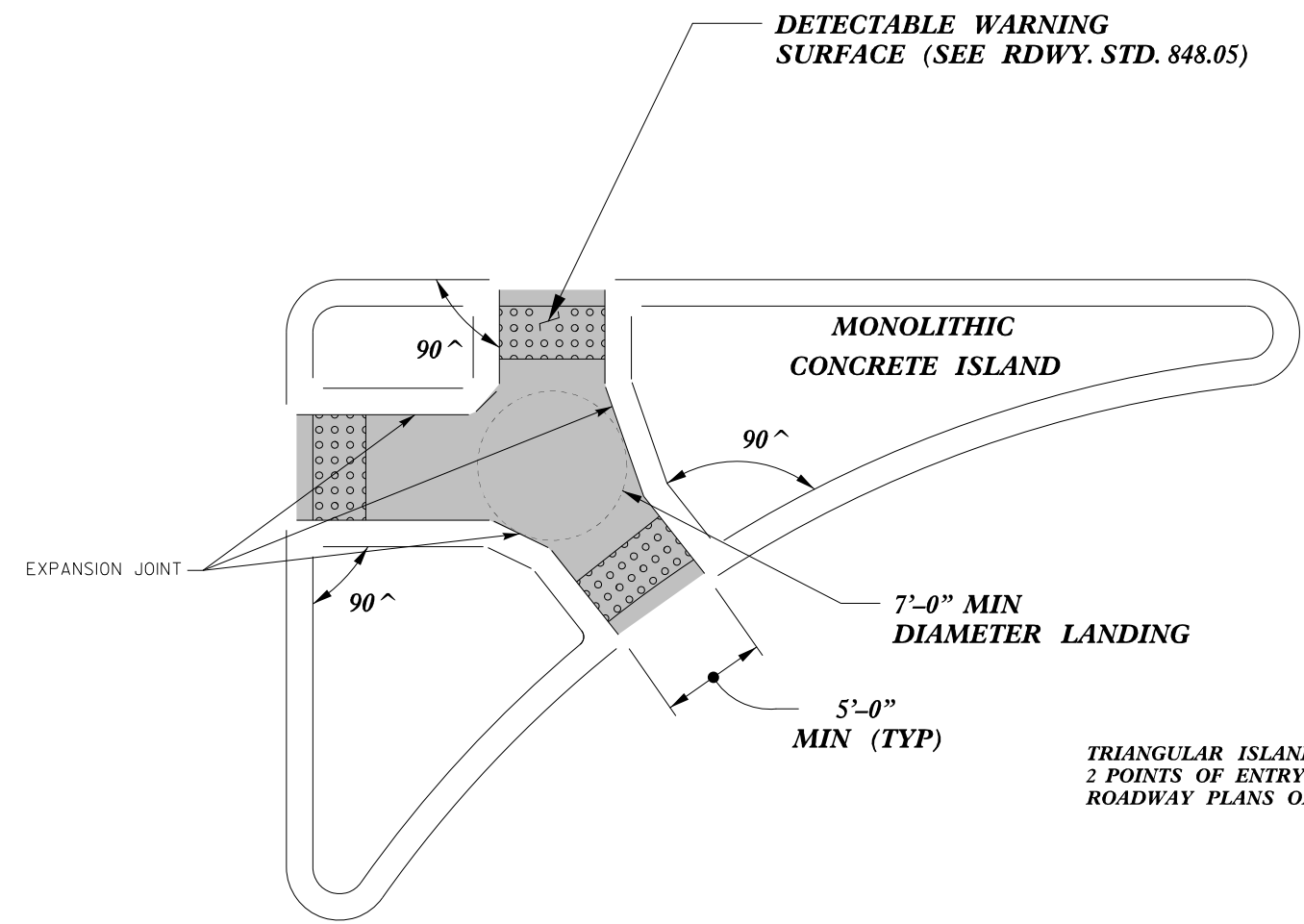

TRIANGULAR ISLANDS MAY BE CONSTRUCTED WITH ONLY
2 POINTS OF ENTRY AND EXIT AS SHOWN IN THE
ROADWAY PLANS OR AS DIRECTED BY THE ENGINEER.

**TRIANGULAR ISLAND
WITH CUT THROUGH
TYPE 6**

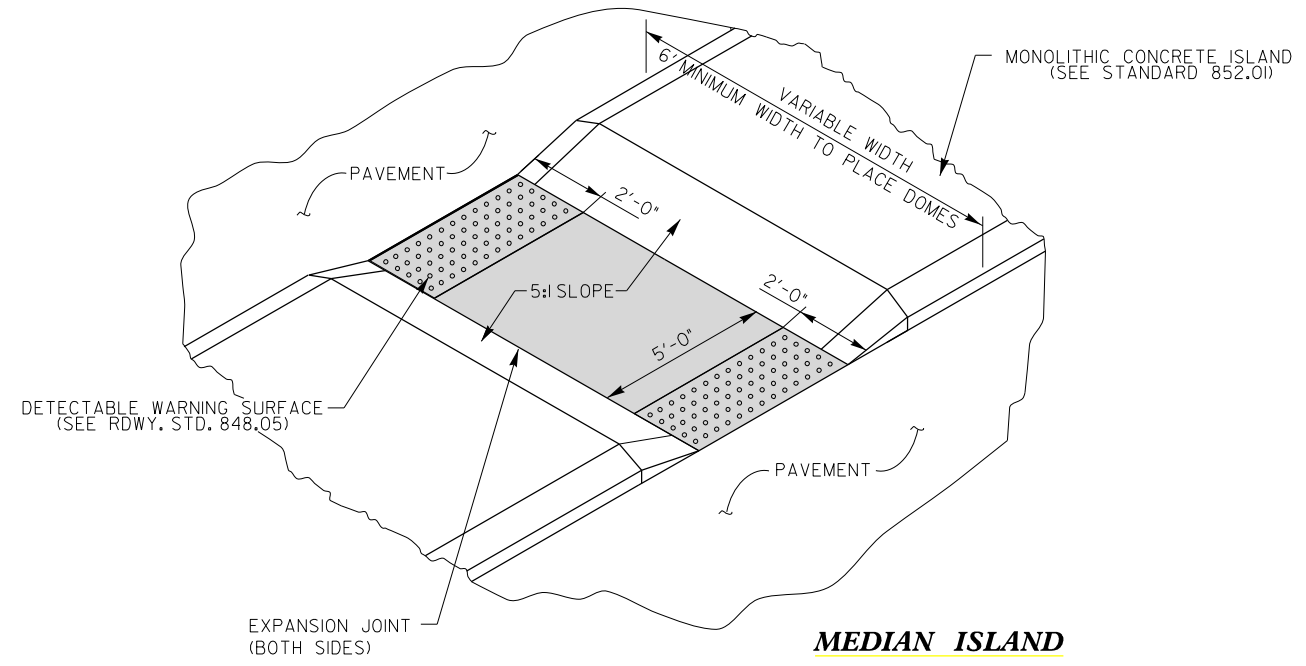

**MEDIAN ISLAND
WITH CUT THROUGH
TYPE 7**

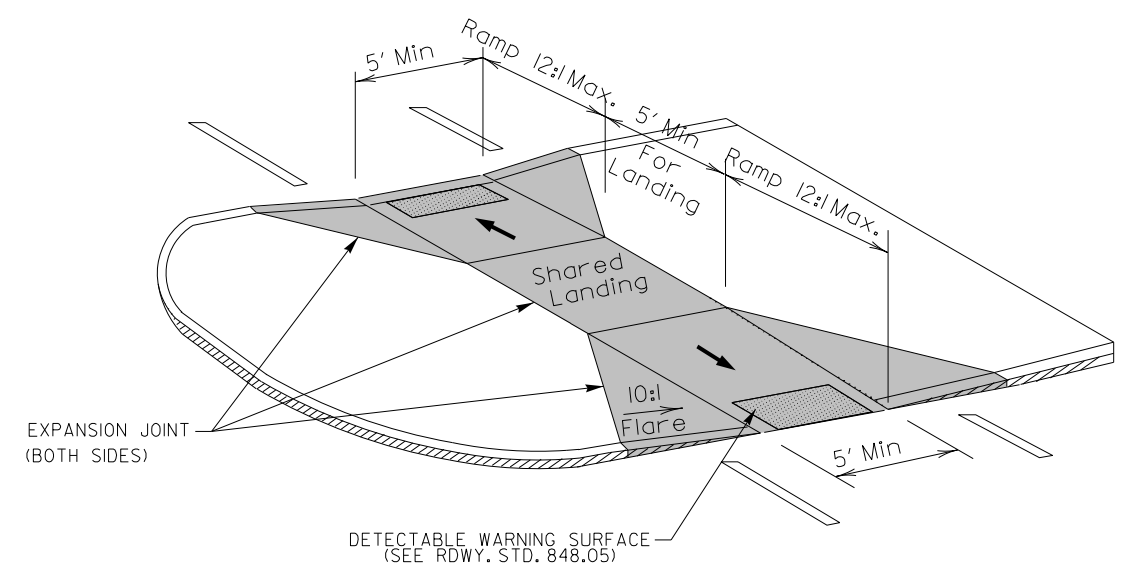

**MEDIAN ISLAND
CURB RAMPS
TYPE 8**

DOCUMENT NOT CONSIDERED FINAL
UNLESS ALL SIGNATURES COMPLETED

CONTRACT STANDARDS AND DEVELOPMENT UNIT	
Office 919-707-6950	FAX 919-250-4119
CURB RAMPS	
Median or Turn Lane Islands	
ORIGINAL BY: J.S. HOWERTON	DATE: 7/7/11
MODIFIED BY:	DATE:
CHECKED BY:	DATE:
FILE SPEC: stds/2012CurbRamp/CurbRampDetails.dgn	

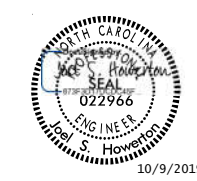

10/9/2019

5/14/99
SYSTEMS ENGINEERING
DESIGN
DRAWING
NO. 022966
DATE: 10/9/2019

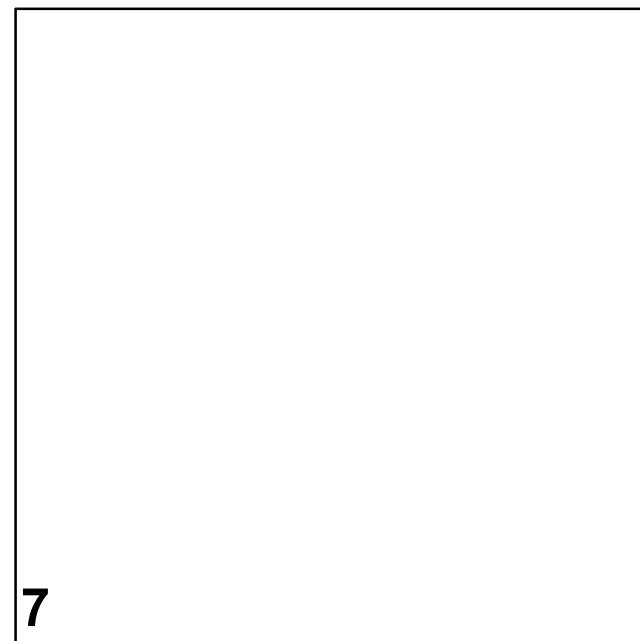
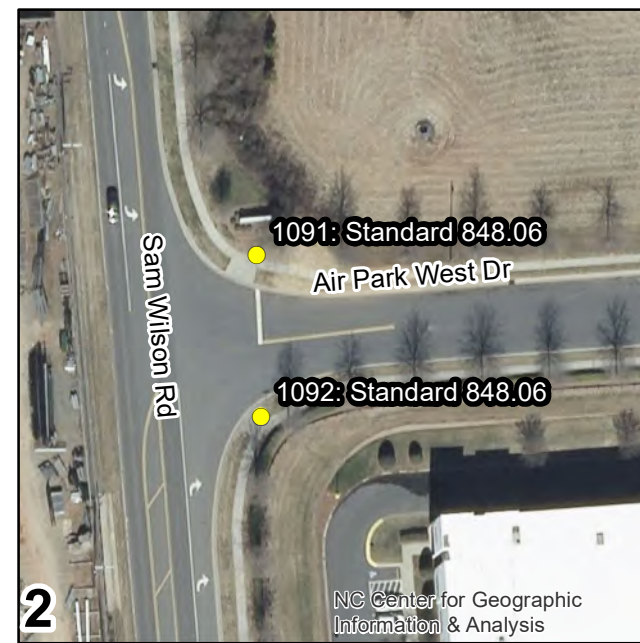
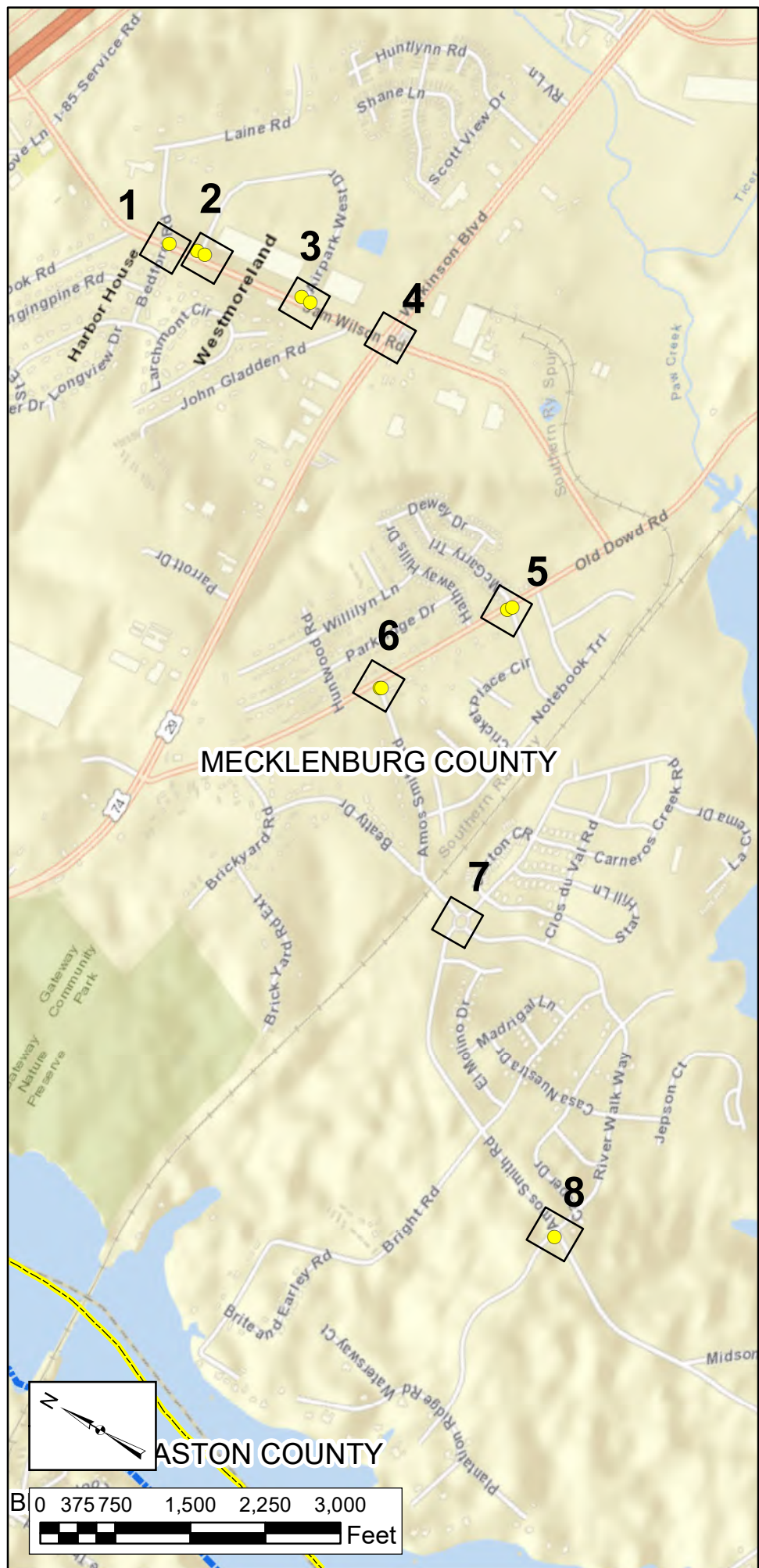

LEGEND

- MISSING
- NOT COMPLIANT
- ▬ MUNICIPAL BOUNDARY
- ▭ NCHPO HISTORIC PROPERTY OR DISTRICT

0 50 100 150
Ft

 NORTH CAROLINA DEPARTMENT OF TRANSPORTATION
NORTH CAROLINA DEPARTMENT OF TRANSPORTATION
DIVISION OF HIGHWAYS

RAMEY KEMP & ASSOCIATES, INC

DIVISION 10 INTERSECTION
ADA IMPROVEMENTS
CABARRUS, MECKLENBURG, AND UNION
COUNTIES
STIP PROJECT R-5790JG
GROUP A

MAP 1-1

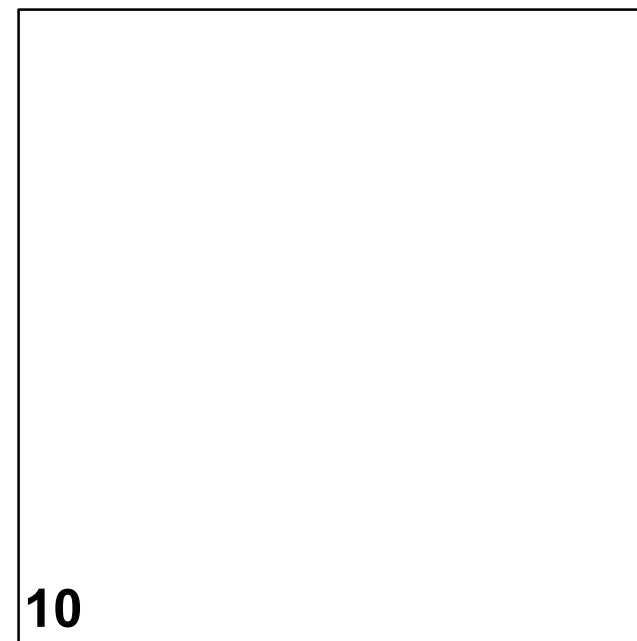
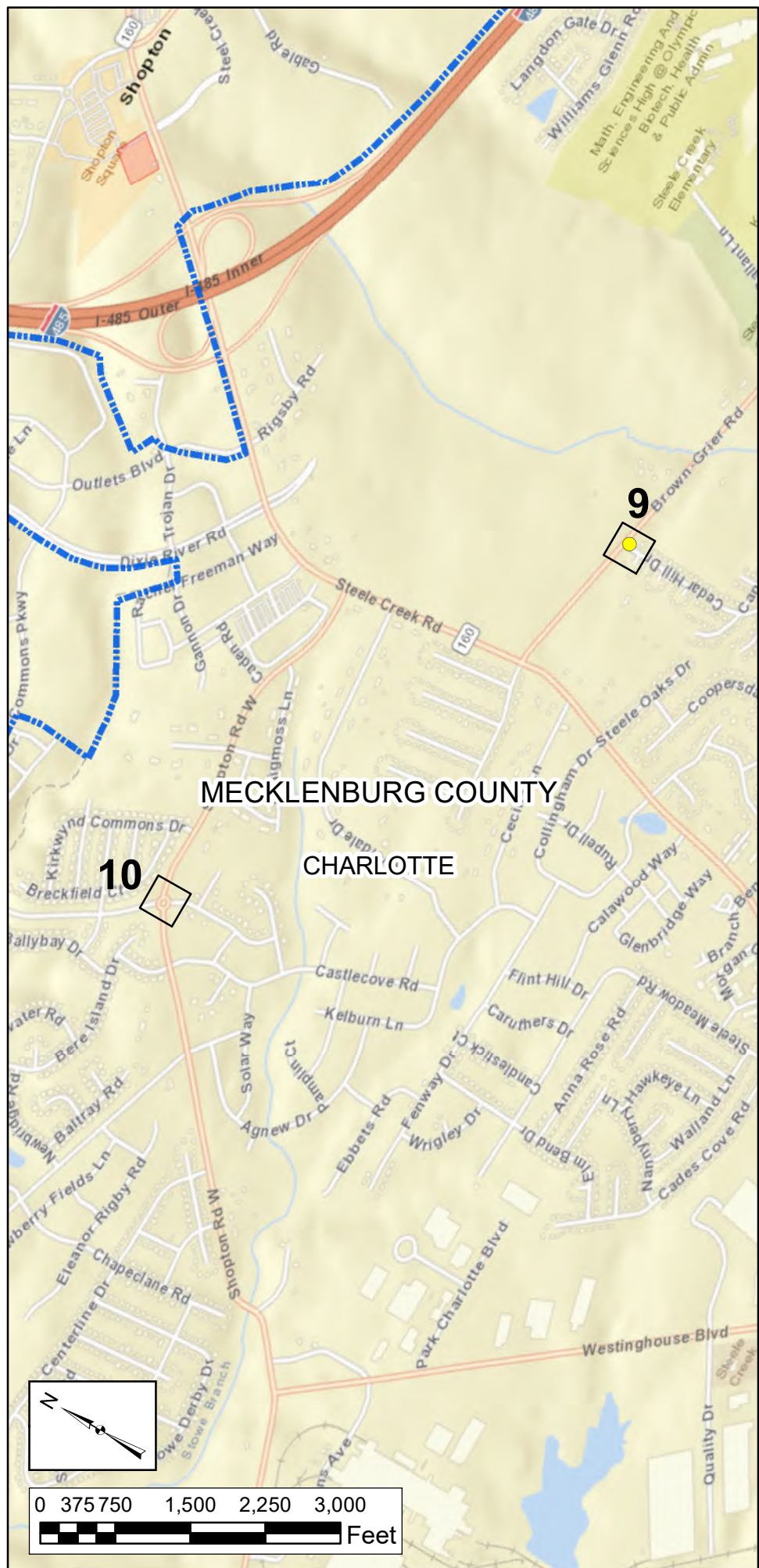

LEGEND

ADA RAMP IMPROVEMENT LOCATION

- MISSING
- NOT COMPLIANT
- ▬ MUNICIPAL BOUNDARY
- ▬ NCHPO HISTORIC PROPERTY OR DISTRICT

0 50 100 150
Ft

 NORTH CAROLINA DEPARTMENT OF TRANSPORTATION

NORTH CAROLINA DEPARTMENT OF TRANSPORTATION
DIVISION OF HIGHWAYS

RAMEY KEMP & ASSOCIATES, INC

DIVISION 10 INTERSECTION
ADA IMPROVEMENTS
CABARRUS, MECKLENBURG, AND UNION
COUNTIES
STIP PROJECT R-5790JG
GROUP A

MAP 1-2

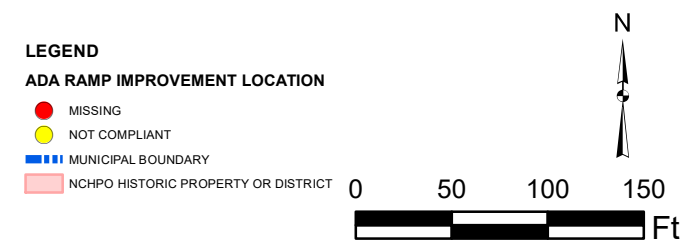
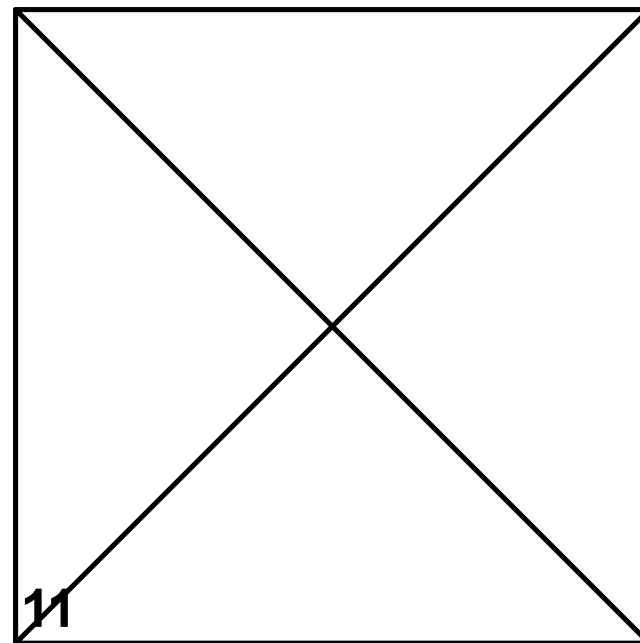
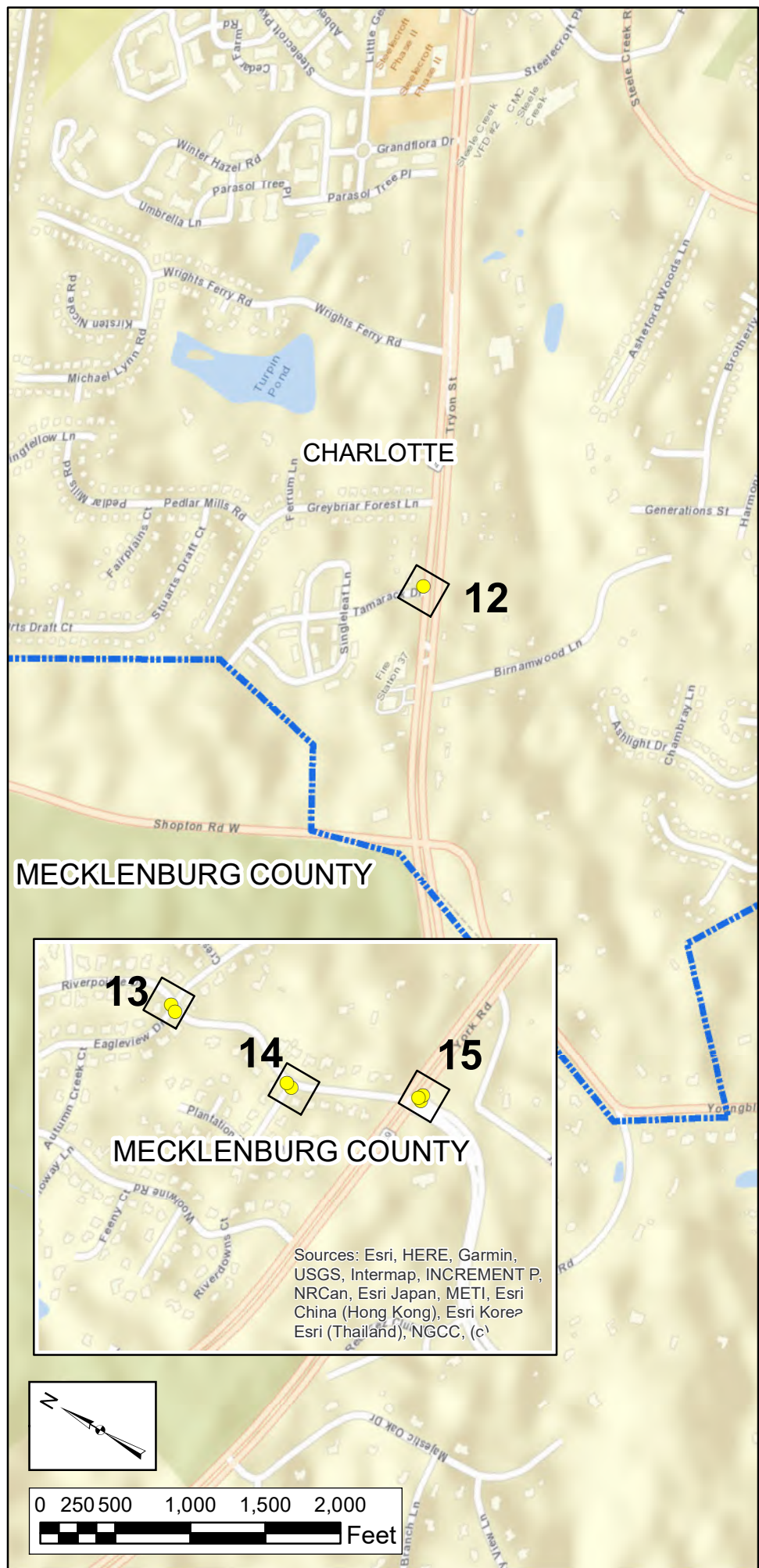

	NORTH CAROLINA DEPARTMENT OF TRANSPORTATION DIVISION OF HIGHWAYS
	RAMEY KEMP & ASSOCIATES, INC
DIVISION 10 INTERSECTION ADA IMPROVEMENTS CABARRUS, MECKLENBURG, AND UNION COUNTIES STIP PROJECT R-5790JG GROUP A	
MAP 1-3	

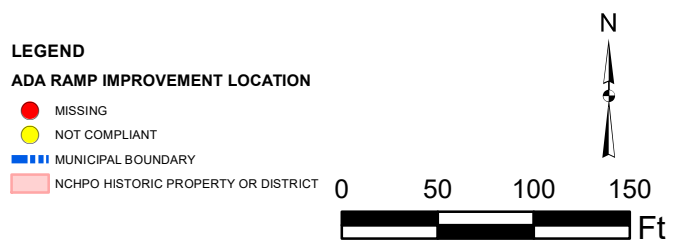
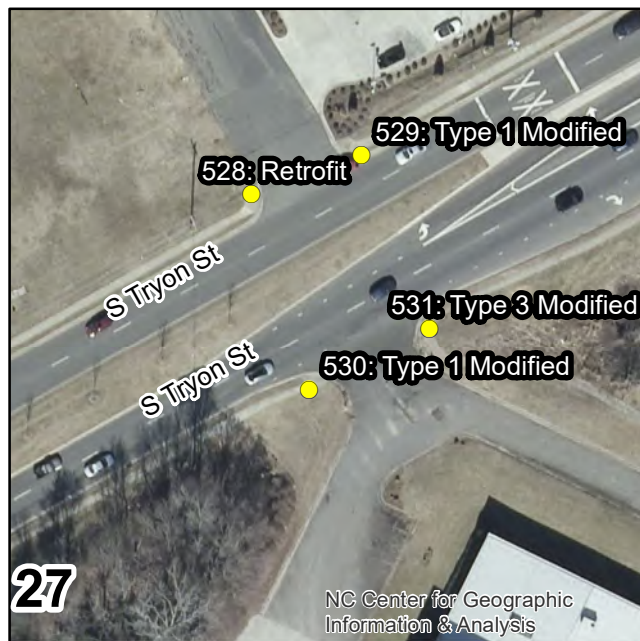
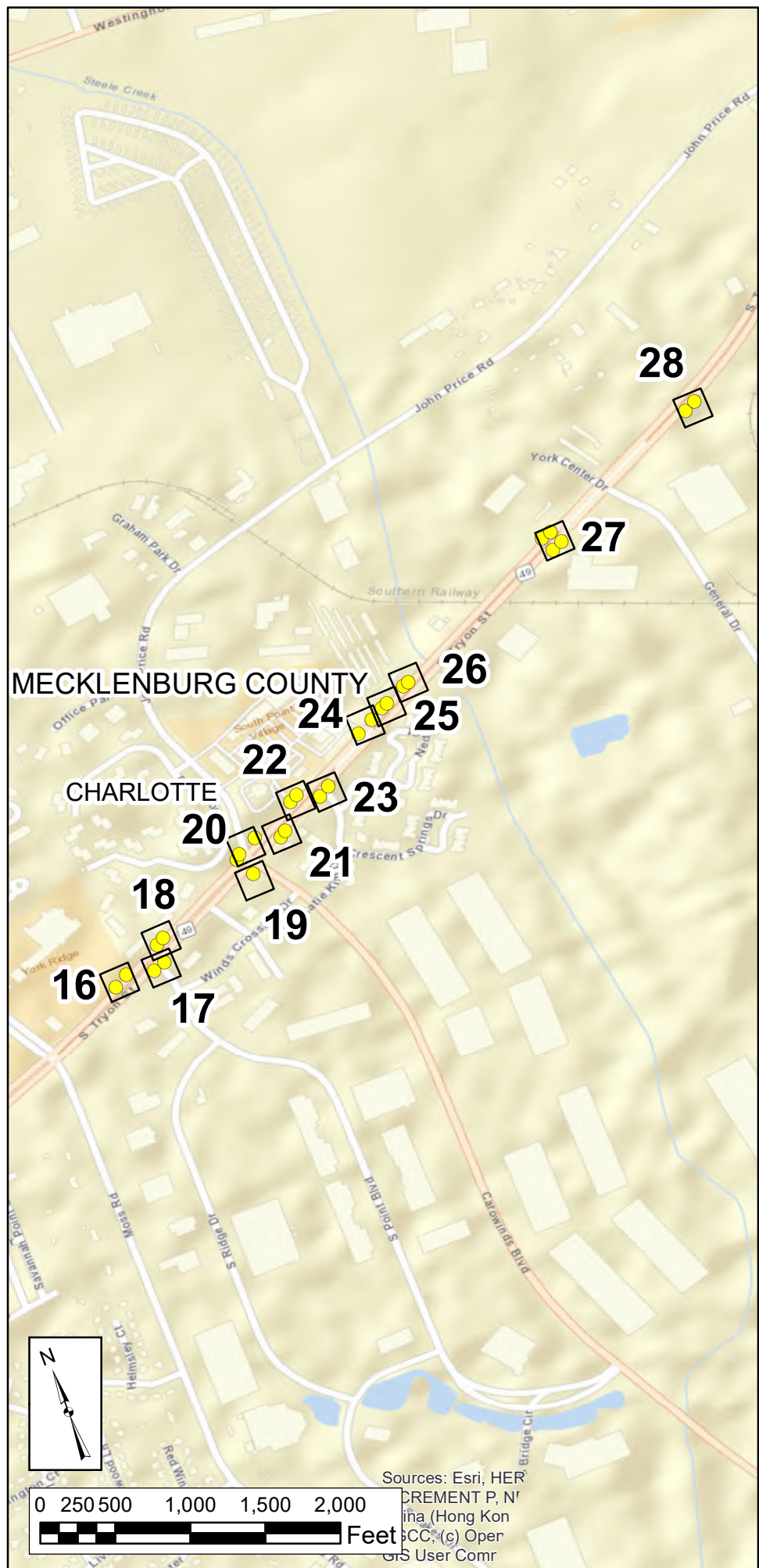

NORTH CAROLINA DEPARTMENT OF TRANSPORTATION
DIVISION OF HIGHWAYS

RAMEY KEMP & ASSOCIATES, INC

DIVISION 10 INTERSECTION
 ADA IMPROVEMENTS
 CABARRUS, MECKLENBURG, AND UNION
 COUNTIES
 STIP PROJECT R-5790JG
 GROUP A

MAP 1-5

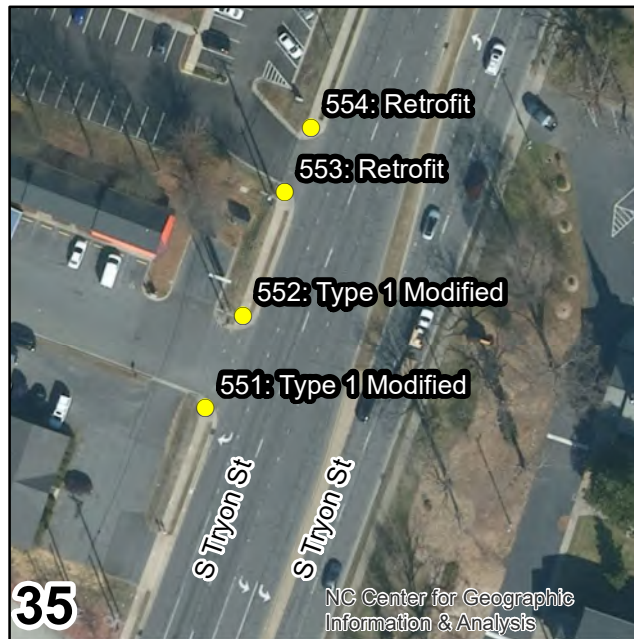
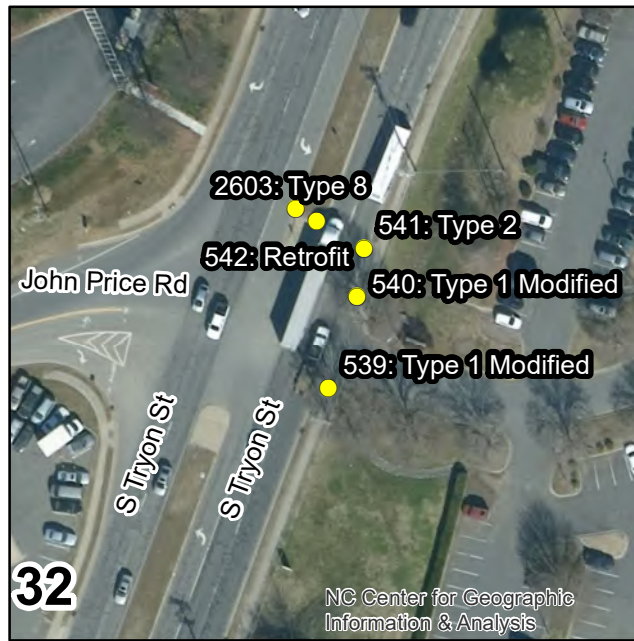
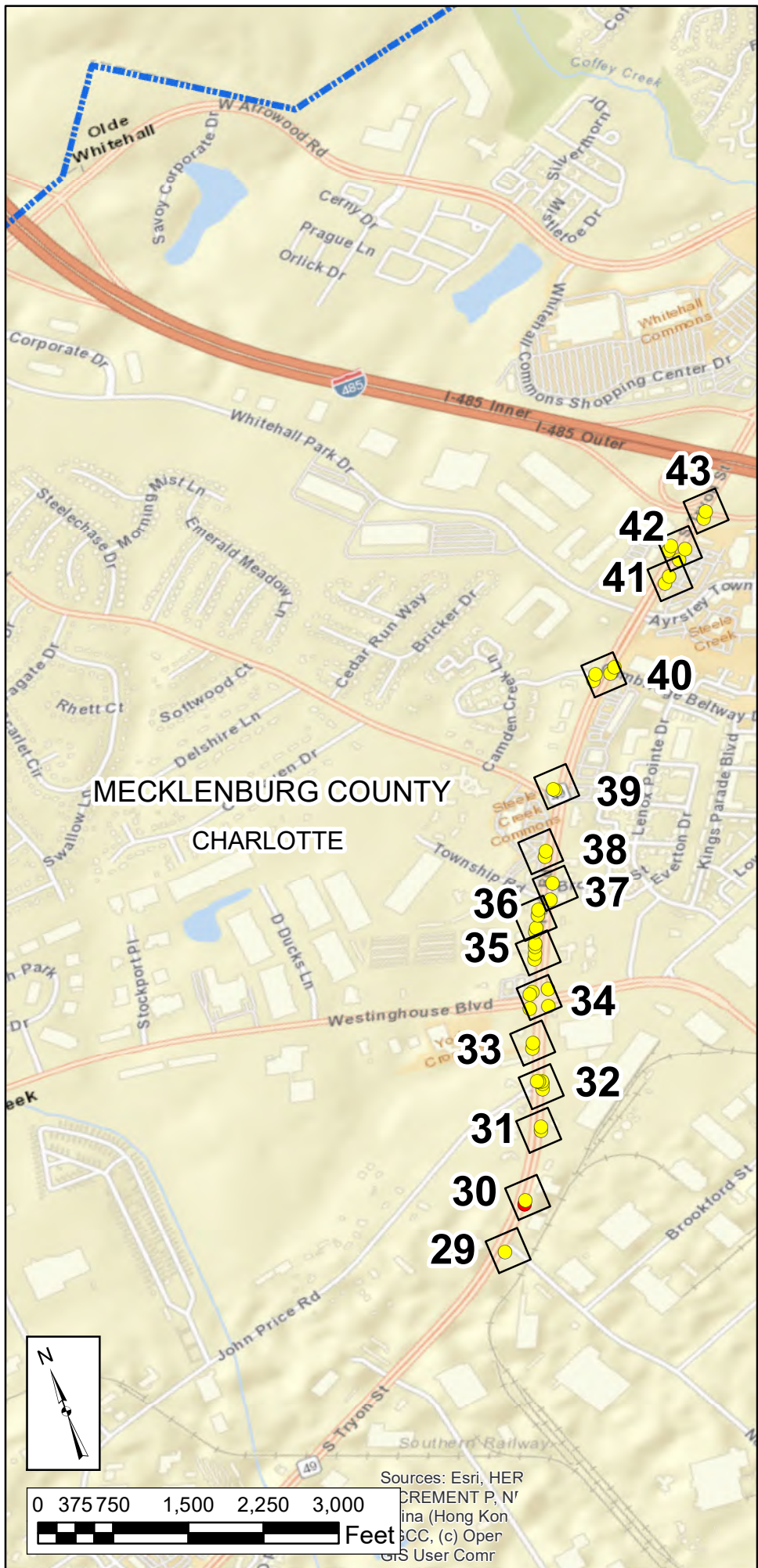

LEGEND

ADA RAMP IMPROVEMENT LOCATION

- MISSING
- NOT COMPLIANT
- MUNICIPAL BOUNDARY
- NCHPO HISTORIC PROPERTY OR DISTRICT

0 50 100 150 Ft

NORTH CAROLINA DEPARTMENT OF TRANSPORTATION
NORTH CAROLINA DEPARTMENT OF TRANSPORTATION
DIVISION OF HIGHWAYS

RAMEY KEMP & ASSOCIATES, INC

DIVISION 10 INTERSECTION
ADA IMPROVEMENTS
CABARRUS, MECKLENBURG, AND UNION
COUNTIES
STIP PROJECT R-5790JG
GROUP A

MAP 1-6

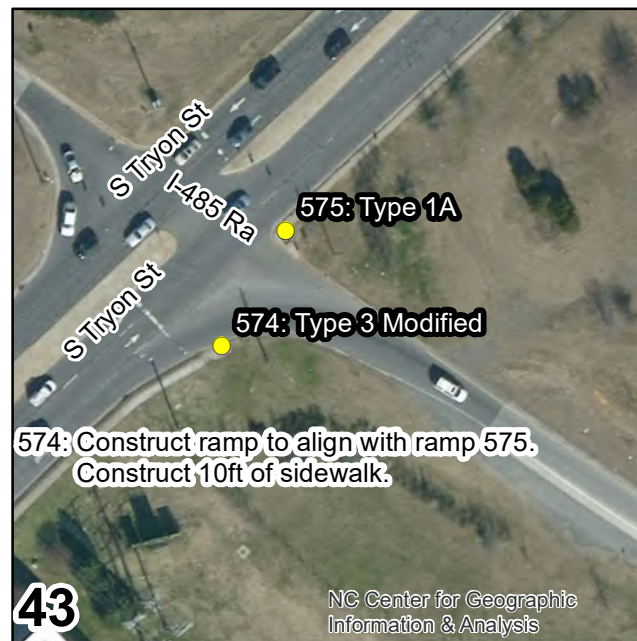
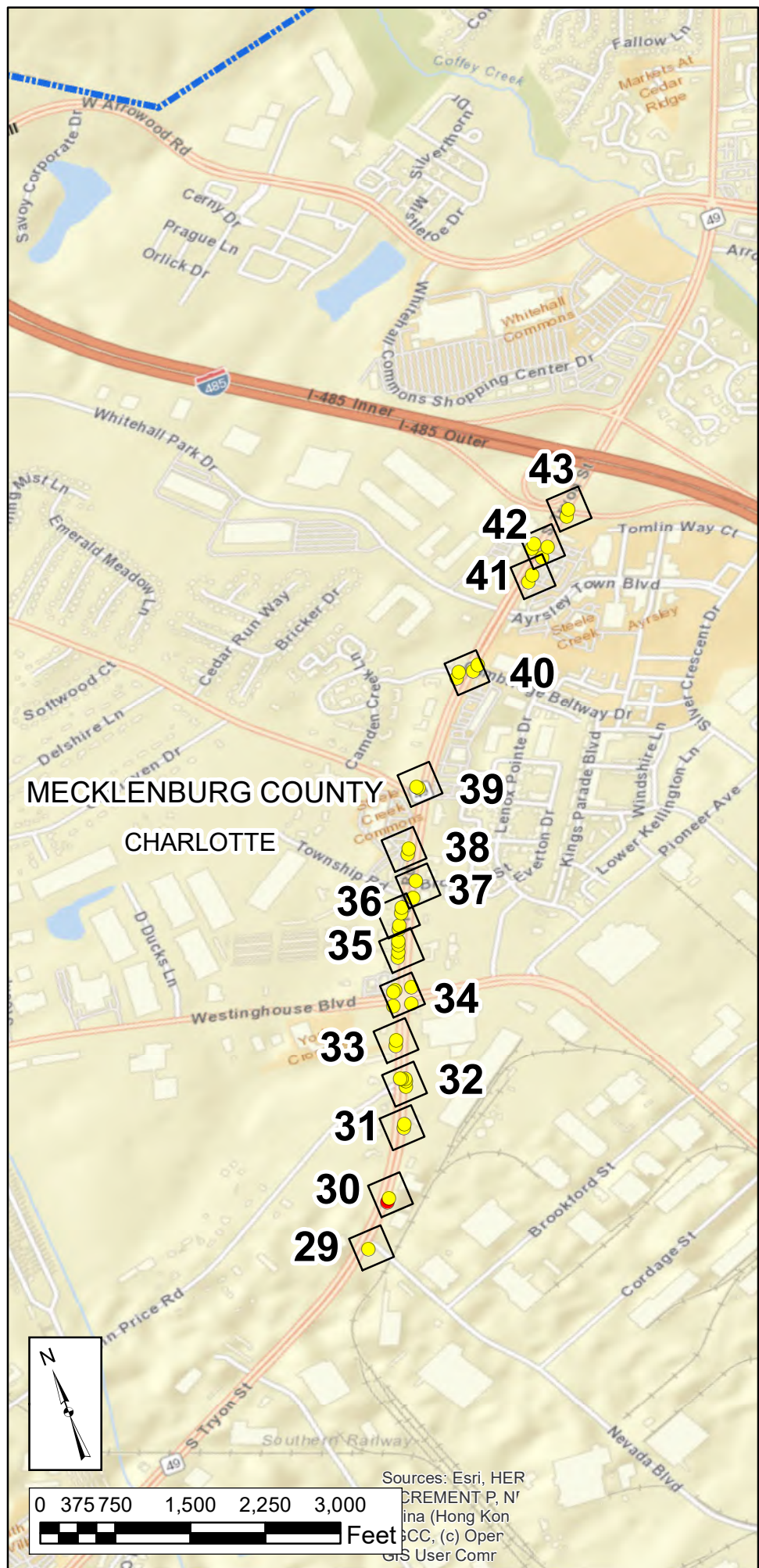

LEGEND

ADA RAMP IMPROVEMENT LOCATION

- MISSING (Red dot)
- NOT COMPLIANT (Yellow dot)
- MUNICIPAL BOUNDARY (Blue dashed line)
- NCHPO HISTORIC PROPERTY OR DISTRICT (Pink shaded area)

0 50 100 150 Feet

NORTH CAROLINA DEPARTMENT OF TRANSPORTATION
DIVISION OF HIGHWAYS

RAMEY KEMP & ASSOCIATES, INC

DIVISION 10 INTERSECTION ADA IMPROVEMENTS
CABARRUS, MECKLENBURG, AND UNION COUNTIES
STIP PROJECT R-5790JG GROUP A

MAP 1-7

SHEET 1-8 REMOVED FROM SET

	NORTH CAROLINA DEPARTMENT OF TRANSPORTATION DIVISION OF HIGHWAYS
	RAMEY KEMP & ASSOCIATES, INC
DIVISION 10 INTERSECTION ADA IMPROVEMENTS CABARRUS, MECKLENBURG, AND UNION COUNTIES	
STIP PROJECT R-5790JG GROUP A	
MAP 1-8	

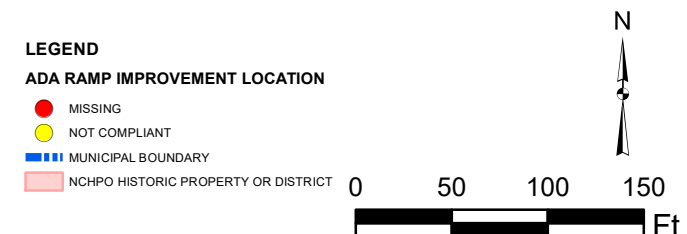
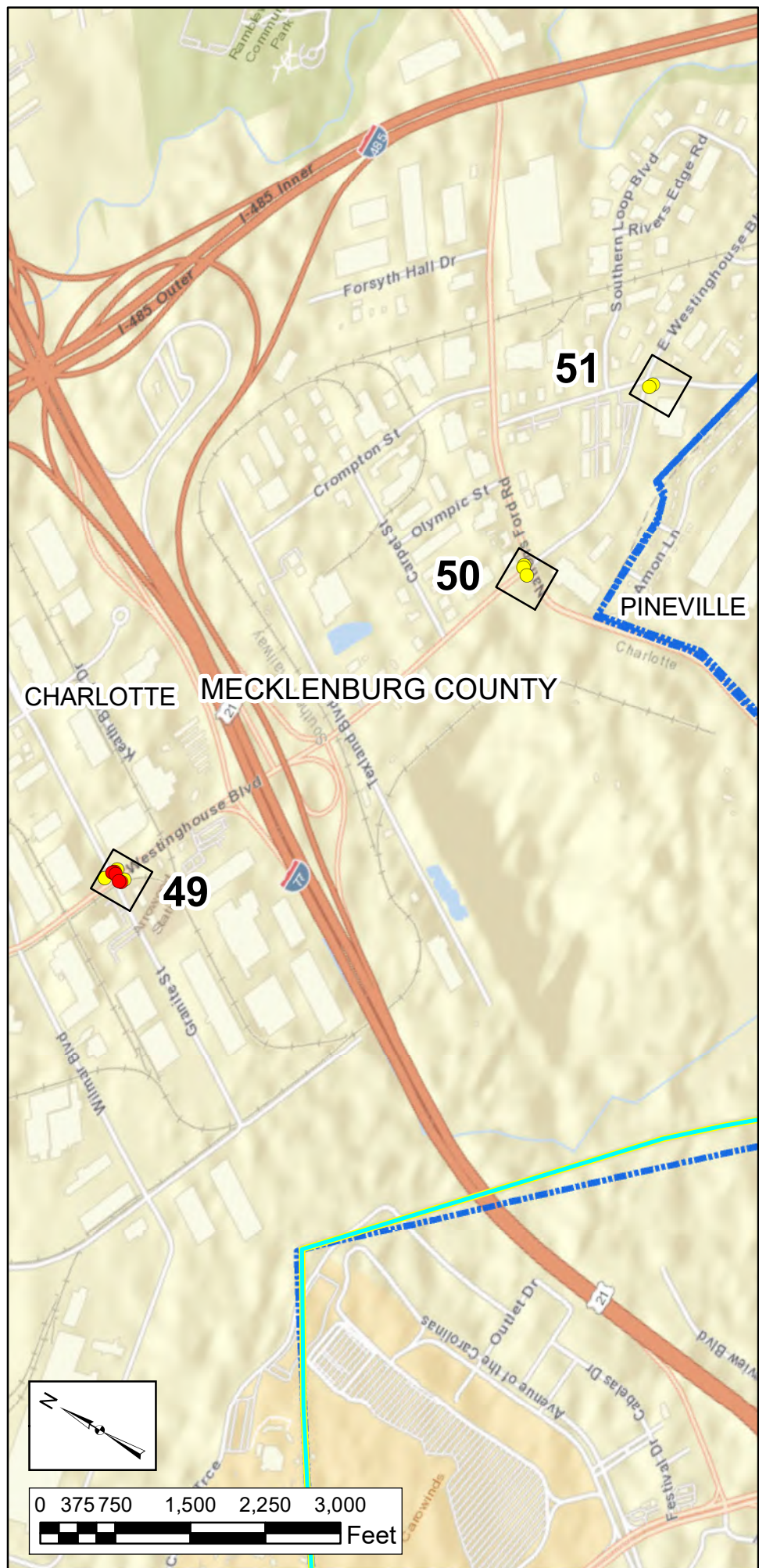

	NORTH CAROLINA DEPARTMENT OF TRANSPORTATION DIVISION OF HIGHWAYS
	RAMEY KEMP & ASSOCIATES, INC
DIVISION 10 INTERSECTION ADA IMPROVEMENTS CABARRUS, MECKLENBURG, AND UNION COUNTIES STIP PROJECT R-5790JG GROUP A	
MAP 1-9	

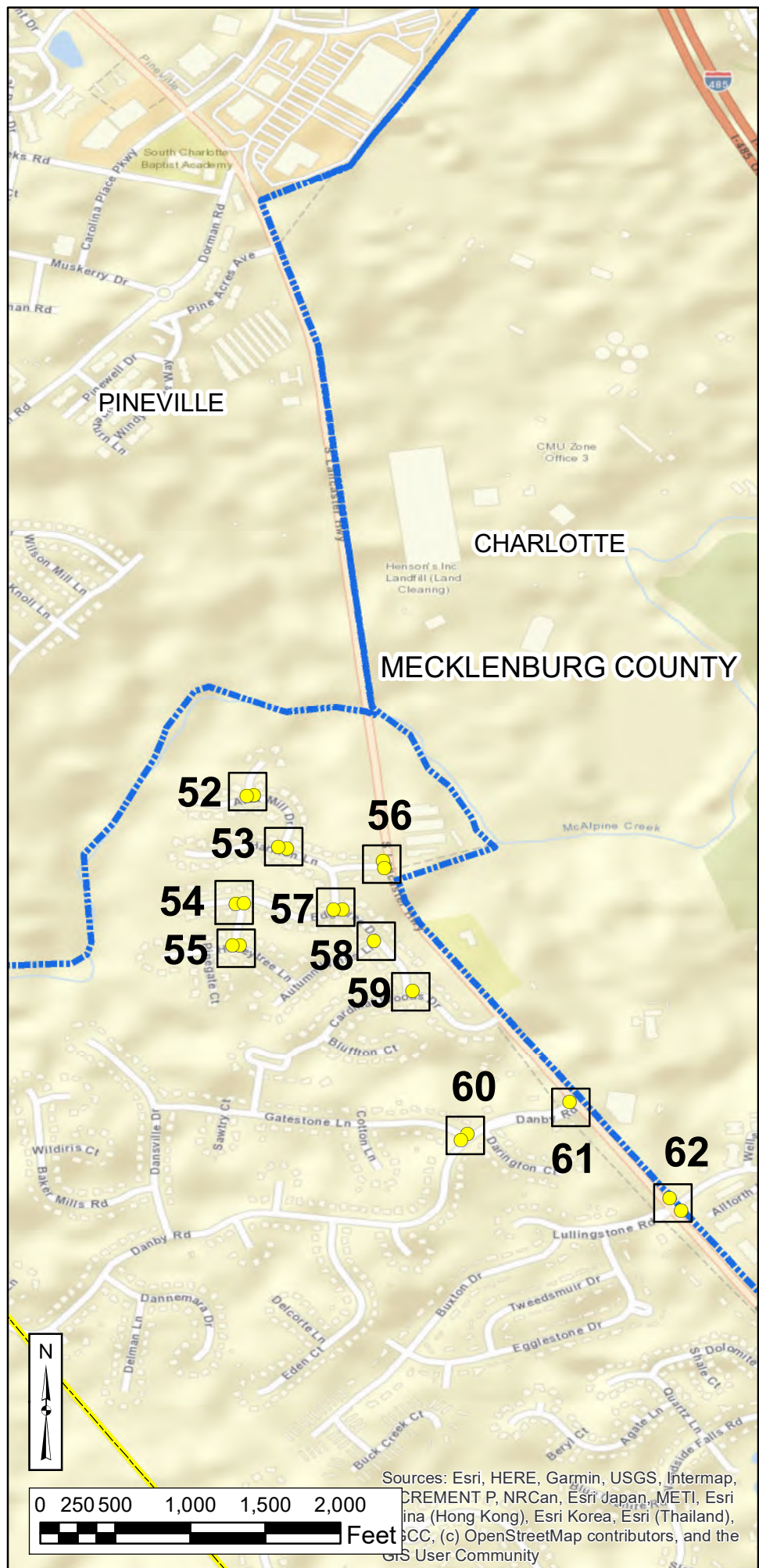

LEGEND

ADA RAMP IMPROVEMENT LOCATION

- MISSING
- NOT COMPLIANT
- MUNICIPAL BOUNDARY
- NCHPO HISTORIC PROPERTY OR DISTRICT

0 50 100 150
Feet

NORTH CAROLINA DEPARTMENT OF TRANSPORTATION
DIVISION OF HIGHWAYS

RAMEY KEMP & ASSOCIATES, INC

DIVISION 10 INTERSECTION ADA IMPROVEMENTS
CABARRUS, MECKLENBURG, AND UNION COUNTIES
STIP PROJECT R-5790JG
GROUP A

MAP 1-10

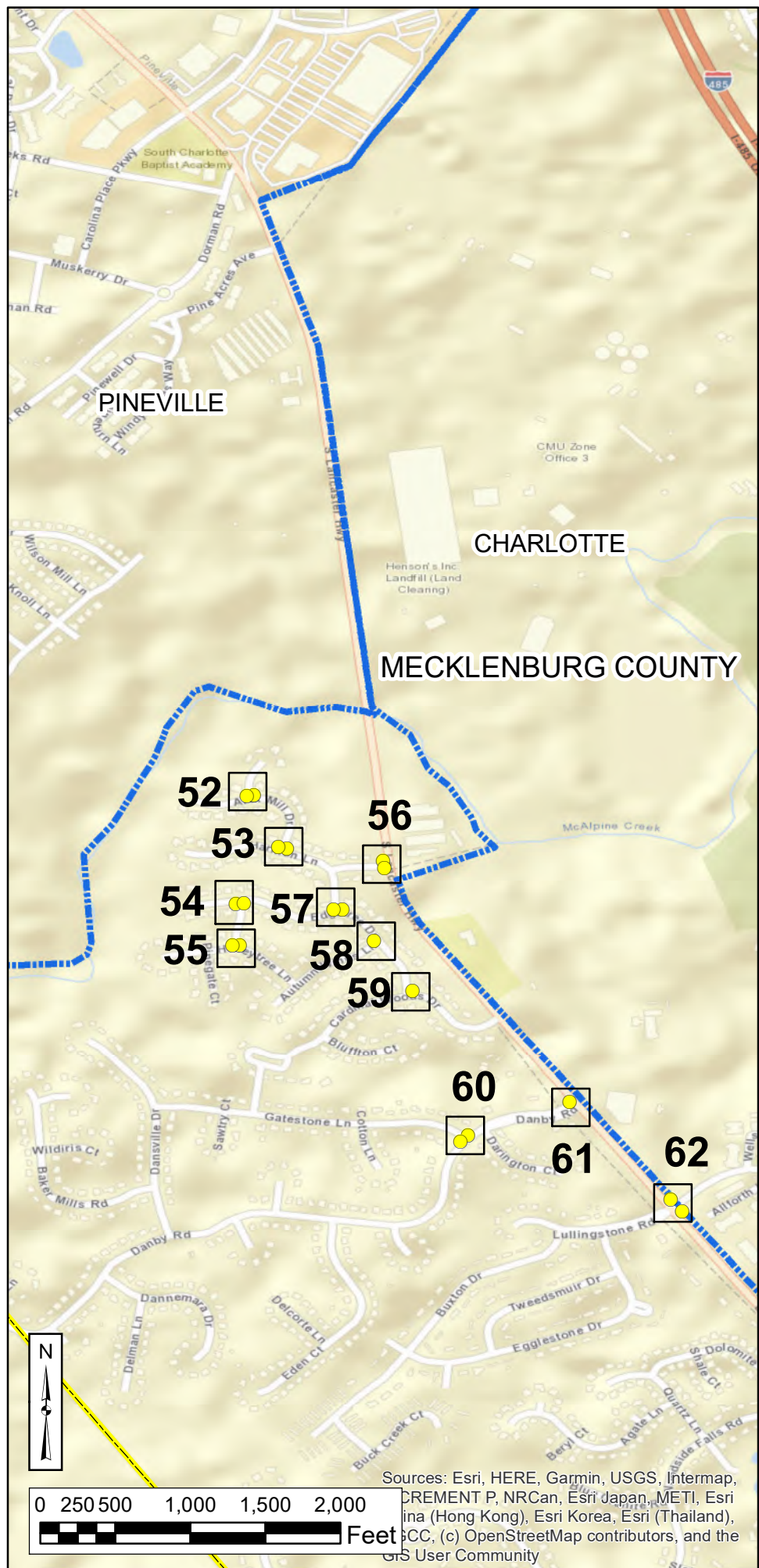

LEGEND

ADA RAMP IMPROVEMENT LOCATION

- MISSING
- NOT COMPLIANT
- ▬ MUNICIPAL BOUNDARY
- ▬ NCHPO HISTORIC PROPERTY OR DISTRICT

0 50 100 150
Ft

 NORTH CAROLINA DEPARTMENT OF TRANSPORTATION
DIVISION OF HIGHWAYS

RAMEY KEMP & ASSOCIATES, INC

DIVISION 10 INTERSECTION
ADA IMPROVEMENTS
CABARRUS, MECKLENBURG, AND UNION
COUNTIES
STIP PROJECT R-5790JG
GROUP A

MAP 1-11